

# Miniature Arms

July 2012

The Journal of  
the Miniature  
Arms Collectors/  
Makers Society

The Worlds Biggest Miniature Arms Publication

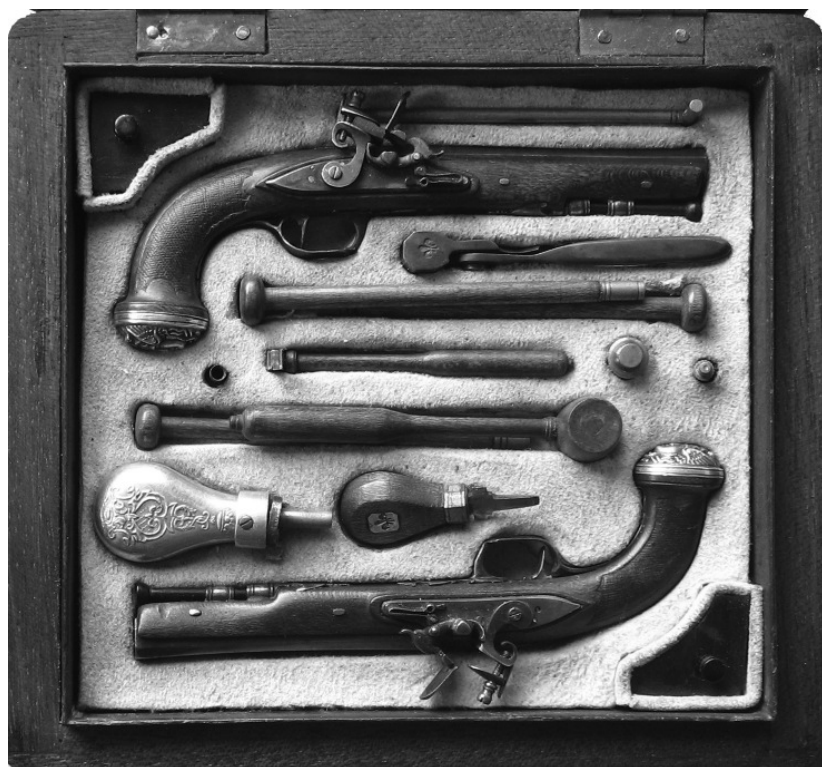

## Flintlock & Percussion Pistols From the Whichard Collection

### Auction Highlights



### Forsyth System Ring Gun



### Gordon Heasman Revolver

Also in  
This Issue

A Jos<sup>h</sup> Child  
Muff Pistol

Antonio Rincon  
Garniture Set

Little All Right  
Palm Pistol

Pinfire  
Page:

# The Miniature Arms Journal

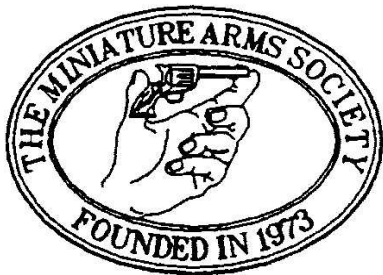

President.....Wayne Driskill  
 Vice President .....Gary Lowe  
 Secretary .....Zavie Kucer  
 Treasurer .....Alice McGinnis  
 Directors.....Bill Adrian  
 .....Ken Whichard  
 .....David Kucer  
 .....Michael Barrett  
 .....Ted Campbell Jr.  
 Corporate Agent.....James Schmidt  
 Editor/Art Director.....Bob Urso  
 Western News .....Gil Metcalf  
 Membership .....  
 .....Carmen & Josie Gianforte  
 Exhibit Directors.....  
 .....Bob & Alice McGinnes  
 Plan Librarian.....Carmen Gianforte  
 Webmaster.....Dr. Brad Maxfield

The Miniature Arms Journal (formerly Shooting The Breeze) is published four times a year for and by the members and friends of the Miniature Arms Collectors/Makers Society, Ltd.

The current renewal dues are:  
 United States \$35.00/year  
 Canada & Mexico \$40.00/year  
 All other international \$55.00/year

New memberships will be an additional \$10.00 for the first year as follows:  
 United States \$45.00  
 Canada & Mexico \$50.00  
 All other international \$65.00.  
 New members will receive all available back issues in the current volume. Dues (checks made out to the Miniature Arms Society) and correspondence concerning membership should be sent to

Alice McGinnis  
 2109 Spring Street  
 Cross Plaines, WI 53528  
 Tel. (608) 798-2860

## Society Officers 2012

President  
 Wayne Driskill  
 1707 Spring Glen Lane  
 Pearland, TX 77581-5590  
 Tel. (281)485-1830  
 wdriskill@hotmail.com

Treasurer  
 Alice McGinnis  
 2109 Spring Street  
 Cross Plaines, WI 53528  
 Tel. (608) 798-2860  
 mcginnr@chorus.net

Membership Chairman  
 Carmen & Josie Gianforte  
 664 Francisco Road NW  
 Georgetown, TN 37336  
 Tel (423) 5591546  
 cjgin40@gmail.com.

### The Presidents Message

Hello All,

The NRA Show was a blast for those of us that were there. Ted Campbell was awarded three NRA medals for his wonderful display of miniatures. Many thanks to Ted & Betty Campbell, and David & Zavie Kucer, for their many hours spent manning the MAS booth, answering thousands of questions, and showing the public their wonderful treasures. Educating the public is one of the most important things I feel we can do as a club, and this is a venue where we really get a chance to show what we do to tens of thousands of interested people.

Please take a look at our new MAS Polo shirts and the new Paterson capper keyfob/pendants which are featured in this issue. These are a great way to help support our club and show your friends you collect miniatures. A real big thanks to Michael Mirman who used one of Hersch Kopp's Paterson capper pendants as the model, and had them remade in bronze and sterling silver for the club at his cost for materials and nothing for his labor. THANKS MIKE!!!

I've had a busy year with shows across the country. Interest in miniatures seems to be up and growing slowly but steadily. Now that Summer is here, I'm looking forward to the normal slowdown. It's time I get to spend with family and friends. As I write this, I'm in California visiting relatives. This past weekend my sons and I attended the annual Nevada Light Artillery shoot in Fallon, Nevada hosted by MAS member Vic Williams. What a blast we had! We are all now official Gunnery Sargents, having qualified and shown proficiency in properly loading and shooting muzzle loading cannons of 2" bore or larger. Nick got to shoot a 1863 3" British Whitworth breech loading cannon as used by the CSA during the Civil War. We shot lots of sub machine guns and several World War II belt feds. I have photos and videos and will try to get some of them posted on my website when I get home.

There are elections being held at all areas of government all over the country. Please remember to vote, and to vote for people who will defend and support our rights to collect, own, and shoot firearms.

I look forward to seeing you somewhere in my travels. Until then, keep your powder dry!

Regards,

**Wayne Driskill**

President – Miniature Arms Society  
 (281)485-1830 Office (281)468-7103 Cell  
 wdriskill@hotmail.com

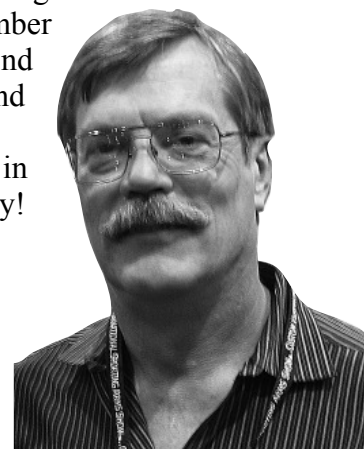

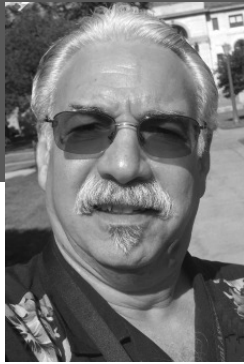

**From  
the  
Editor**

First of all thanks to all those who contributed to this issue. The Show News reports, and photos, the gun and shop articles are essential to keeping this Journal alive.

That said, however, if you look at the table of contents to the right, my name comes up waaaaay too often. I can't keep this up.

I need your help.

Nuff said.

All the best,  
Bob Urso, Editor  
boburso@comcast.net  
tel. 360-733-4406

# In this issue

Letters & email .....	4
New Members.....	6
Alice's Corner .....	6
Timonium Gun Show News by Coral Whichard ....	7
Baltimore Antique Gun Show News by Bob & Alice McGinnis .....	8
NRA Show News and Silver Medal Winners by Ted Campbell .....	10
A Gordon Heasman Revolver by Bob Urso .....	13
Miniatures from the Whichard Collection Flintlock & Percussion Pistols by Bob Urso .....	14
Little All Right Palm Pistol by Bob Urso .....	20
Boutet Garniture Set by Antonio Rincon .....	22
A Jos <sup>h</sup> Child Percussion Boxlock by Ron Weingarten.....	24
Forsyth System Ring Gun by Wayne Driskill .....	26
Xu Yan's shop .....	27
Auction Highlights by Bob Urso .....	28
The Pinfire Page A Czech pistol and more.....	30
Websites & Wired - Members email addresses.....	32
Shop or Swap .....	34

# Letters



## and Connections

### Jim Kelly's Email

Mr. Urso -

I joined last Spring, attended the NRA show.

My email is: jkellymetal@gmail.com should you choose to include it in MAJournal

Jim Kelly

### Werner E. Emrich Email

Hi Bob,

I don't think I ever provided my E-mail address to be included in the magazine.

It's lionel2341@yahoo.com

Thanks, Werner E. Emrich

### Carmen On the Go...

Bob,

As usual i'm staying too busy. Currently working on Kolibri cartridges. I have only to make the anvils for the primer cups. I took the time to install indicators for the tailstock, saddle, and cross slide of my lathe.

I hope to get back to my Reid miniatures after the cartridges are completed. Another side project is an elliptical chuck. This will cause the lathe to produce an elliptical

shaped part instead of a circular part.

Have you ever heard of a Rose Engine Lathe? These were ornamental lathes produced during the 19th century. There is a fellow by the name of David Lindow who is producing a modern version of this lathe. I am going to Scranton, PA in September to see this lathe.

That's all for now.

Carmen Gianforte

### A Hi from the Whichards

Hi Bob,

You know we appreciate so much all you do to support MAS--your journal is the glue that holds us all together--Kennith says that without it, there would be no MAS!

We enjoyed having you in our home; you're welcome anytime--maybe then you could even cook one of those Italian meals you described when you were here.

Come again soon,  
Kennith & Coral

# New Members

*Be sure to welcome our new members from around the world*

**Rodney Barron,**  
4609 Lei Street,  
Fair Oaks, CA 95628  
Tel. 916-962-1204)  
rbarron@pol.net)

**James Briglia, Sr.,**  
4306 Willow Heath Dr.  
Pittsburgh, PA  
jamescoruette@yahoo.com

**Robert Colardo,**  
67 Warman Avenue,  
Cranston, RI 02920  
tel. 401-944-1134

**Kenneth Kolt**  
897 Foxlair Tr,  
Richmond Hts OH 44143

**Brian Taylor**  
100 Strawberry Lake Rd  
Whitmore Lake MI 48189  
tel. 810-231-9038

### The new MAS Paterson capper keyfob/pendants

A great way to support our club and show your friends you collect miniatures.

Prices  
bronze \$10.00,  
sterling silver \$35.00.  
All proceeds go to the MAS.

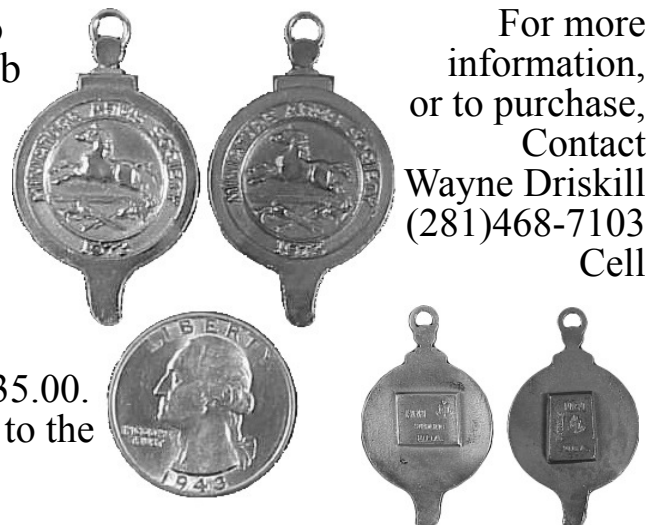

For more information, or to purchase, Contact  
Wayne Driskill  
(281)468-7103  
Cell



# Miniaturny starého pána

Komův rukou a manských vřetech se na světě USA odvíjí dějiny této výjimečné miniaturní zbraně. Někdy dokonce převyšují na její velikosti a přesahujícího dolehu zbraně reálného světa. Všechno to dohromady tvoří Antonio Rincón. Je to mezikarabina výjimečně miniaturní zbraně a sábovní vřetech vřetech a jeho jež se nazývá "Depose".



Antonio Rincón je mezikarabina výjimečně miniaturní zbraně a sábovní vřetech vřetech a jeho jež se nazývá "Depose". Je to mezikarabina výjimečně miniaturní zbraně a sábovní vřetech vřetech a jeho jež se nazývá "Depose".



Antonio Rincón je mezikarabina výjimečně miniaturní zbraně a sábovní vřetech vřetech a jeho jež se nazývá "Depose". Je to mezikarabina výjimečně miniaturní zbraně a sábovní vřetech vřetech a jeho jež se nazývá "Depose".

Advertisement for 'Aster' featuring a logo, contact information (přibytelce centrum, Husarova 18, 100 00 Praha 8), and a small map. It also includes a list of items for sale with prices.

Dear Bob, sorry for the delay, but I was waiting for the issue of the Strelecka Revue magazine, which I have included some photos. CAPTIONS OF THE GARNITURE SET. The magnificently cased five-piece garniture of gold-mounted arms by the premier arms maker of early 19th century France, Nicolas-Noel Boutet of Versailles, comprises one carabine, two pairs of pistols, with an assembly of tools and accoutrements, and bear five extraordinary paper labels noting

presentations of other Boutet arms by Premier Consul Bonaparte in 1803 to Don Federico Gravina y Nápoli ( 1756-1806 ), Don Federico Moyua, Captain of the San Telmo; Captain d'Spinola of the San Joaquin, Don Diego Butron y Cortés, Capitan of the Vigilente; and Captain Castillo of the Nuestra Señora de la Atocha. This garniture was made by Antonio Rincón at 1/3 at scale. All the best, Antonio. antoniorincomminature@hotmail.com

## Mini sold at Herman Historica Auction.



ED. The Flintlock, shown above, was Lot No. 554 at the April 23 Herman Historica auction. It was described as follows.

Miniature flintlock pistol, Ordonnanzwaffe Prussian style, richly detailed, moving in all parts of reproduction. From octagonal to round barrel, length 95 mm. Total length 155 mm. Walnut full stock with brass furniture. Wooden ramrod. OAL 4"



ED. A good view of the action in a "Depose" knuckleduster. On the right note the tiny wire spring that pushes the trigger forward.

# I promise you'll look this good in your new MAS PoloShirt

Now available for both men and women. these new MAS Polo Shirts are a bargain, priced at only \$25 Available in most sizes, with all the profits going to support the Society. To purchase a shirt, or for more information, contact Alice McGinnis via phone at (608) 798-2860 or via email at mcginnr@chorus.net





# Alice's Corner

Alice McGinnis

We have had a very busy spring going to the shows, etc. At the NAMES show there just happened to be a quilt shop across the street. You guessed right, I like to quilt (check with Paul Hamler, Dave Butler and Bob Shutt, they had to look at all my purchases and ooh and ahh!!). On another note, Marcia Butler likes to knit. Mary Kucer is a master in stain glass. My point is unless you all get some articles to Bob Urso for the Journal we ladies might just have to send Bob our articles!!!

We would like to continue a section on different members. If you remember, the last issue highlighted Jim Foley's life. It included his early life in the war, etc. Are there any members who would like to send something in on their life, including their interest in miniatures? If you don't feel you are a good enough writer we would be pleased to help edit any article you submit if you wanted the help. We are looking for pictures of your shop, your miniatures, etc. Let's make Bob's job easier!

It seems all the shows come at one time. Our next show is the local steam show in the Wisconsin Dells area in August. We are planning to attend the Vegas Antique Show in January. As you will read in this issue Sherline is looking for some miniatures to display in their museum. They would like a commitment of one year. We plan to drive to Vegas and continue on to San Diego to take some miniatures to them for the museum.

If you would submit something we'd be glad to coordinate this for you. Just let us know. Sherline said they would pay for all shipping, insurance, etc. for whatever is submitted. Here is our chance to get the word out of Miniature Arms Society. We hope we have a good response for this opportunity.

Alice McGinnis

## CRAFTSMANSHIP MUSEUM REQUEST

We have a special request from the Joe Martin Foundation for Exceptional Craftsmanship

that the Miniature Arms Society consider putting some of our miniature guns/knives on display in their Museum. If you recall, David Kucer and Michel Lefaivre have been featured as Craftsman of the year in recent years.

Craig Libuse told us they would want the display for one year. They would pay for shipping and insurance to their headquarters in San Diego. This seems like a wonderful opportunity for Miniature Arms to get more visibility. At this time we are considering taking some of our miniatures to them after the Las Vegas Antique Show in January. If anyone would like to consider sending something they can contact us (mcginnr@chorus.net) or 608-798-2860 or Craig Libuse (craig@sherline.com) or 760-727-5857.

To check out the Museum look at Sherline's Web Site at [www.craftsmanshipmuseum.com](http://www.craftsmanshipmuseum.com). Craig indicated they redesign their Museum periodically and would really like to feature miniature guns/knives etc. Please consider displaying some of your treasures.

# Upcoming



# Events

Baltimore Antique Arms Show,  
March 16 & 17, 2013

North American Model Engineering Expo,  
April 20 & 21, 2013  
at Wyandotte, MI.

NRA Annual Meeting,  
May 3, 2013 at  
Houston, TX

Baltimore Antique Arms Show,  
March 15 & 16, 2014

NRA Annual Meeting,  
April 25-27, 2014 at  
Indianapolis, IN.

For more information, contact Bob or Alice McGinnis  
Tel. (608) 798-2860  
[mcginnr@chorus.net](mailto:mcginnr@chorus.net)

# News... Timonium Gun Show

We arrived in Timonium Friday afternoon in time to join the others who were setting up for the show and enjoy supper together at the Nautilus, an excellent “silver diner” just up the street.

I can't prove it with photos from that evening, but there were several of us, including Zavie, David and Mary Kucer, Alice and Bob McGinnis, Ron Olsen, Kenneth and me. The menu was enormous, but many chose the excellent Maryland Style crabcakes--very little “filler” and loads of lump crab meat---and two desserts that were shared by anyone who wanted a taste!

Everyone seemed well-pleased with the gun show. As always, there was good attendance and lots of interesting and historical exhibits. The MAS table was well-manned by Alice and Bob, who had many beautiful pieces on display. In other areas of the hall were Zavie, David and Mary Kucer with their beautifully built pieces, Wayne Driscoll with two tables loaded with fascinating miniatures he was ready to educate about and possibly sell, as well as Peter and Wendy Dyson, who arrived from England with their beautiful works and tools, and Ron Weingarten with an interesting exhibit, also. I think any miniature arms enthusiast would have been impressed to see so many displayed in so many

areas at the Timonium show!

There, you have it all now, If you couldn't make it, we missed you in Timonium, but hope to catch up with you all next time.

Take care,  
Coral Whichard



*Other members spotted at various shows included (left) Paul Hammler, Top Bob Shutt with Bob and Alice, and below-Right Jim Kelly.*



*On the left are photos taken Saturday night at another great Timonium restaurant, The Silver Spring Mining Company. As you can see, my little cell phone camera and I did our best to capture one side at a time. In the top photo are David and Mary Kucer, Alice and Bob McGinnis, and Ron Olsen. The bottom photo shows Kenneth Whichard, Wayne Driscoll, Victor Visalli and his sweet wife, and Zavie Kucer.*



*Left: a Tom Weston, Winchester with ivory stock, and engraved frame.*

# News... 2012 Baltimore Antique Arms Show

**From Alice and Bob McGinnis**

Once again the Baltimore Antique Arms Show was a huge success. The weather was awesome. Cherry trees were in full bloom and many members attended: Wayne Driskill, Kenneth and Coral Whichard, David, Mary and Zavier Kucer, Carl Toppel, Vic and Flo Visalli, Jerry and Becky Mismiser, Theresa and Charlie Williams, Ron Weingarten, Harland Woods, Bill Noble, Ron Olson, Bruce Feinberg, and Bob and Alice McGinnis.

We picked up a new member: Ken Kolt, 4897 Foxlair Trail, Richmond Heights, Ohio, 44143. Ken is a member of the Sharps Collector Assoc. and a collector of miniature pin fires. Welcome to the Miniature Arms Society, Ken.

Dan White stopped by with his flint-knapping display. He'd been at our table a few years back as a teenager showing what he had accomplished at that time. This year his display was incredible. Dan is featured in the Sherline Craftsmanship Museum ([www.craftsmanshipmuseum.com](http://www.craftsmanshipmuseum.com))

If you've never attended this show it is certainly worth the trip. The 2013 Show is March 16 & 17. We had the good fortune to visit friends we made last year on our trip, Ken Kranzsuch in Alabama, and Bob Rothen and Hunter Davidson who both live in Maryland. Very enjoyable!

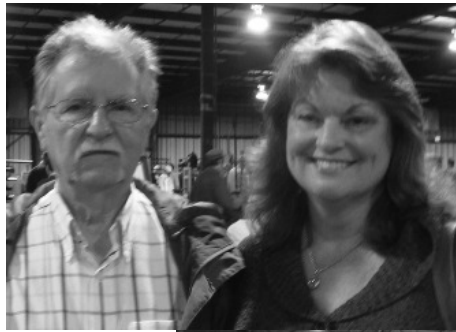

*Left: Kenneth Whichard, and his lovely wife Coral, who is trying to teach him how to smile when he has a picture taken.*

*Below: Our always smiling MAS president, Wayne Driskill.*



*Right: a couple of Henry Loos mini knives.*

*Below: David Kucer at his table, always happy to talk minis.*



*Teresa and Charles Williams with Bill Noble*



*Karl Toppel*



*Dan White with Bob McGinnis*



*Hunter Davidson*



*Above: an impressive group of flint-knapped mini arrow heads by Dan White.*



*Left: Jerry Missmer brought along some of his excellent mini knives for all to see.*

*Below: Antique, muff pistols, possibly made in England.*



*Above: a mini tomahawk and dagger by Henry Loos.*

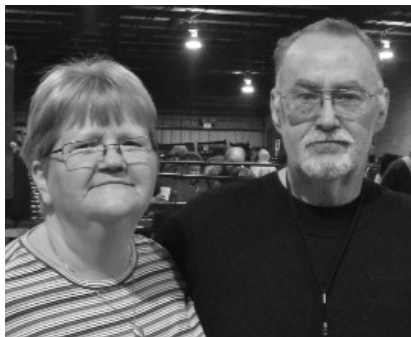

*Becky and Jerry Missmer*



*The two Rons, Weingarten and Olsen*

# HERSCHEL KOPP BOOK A MUST

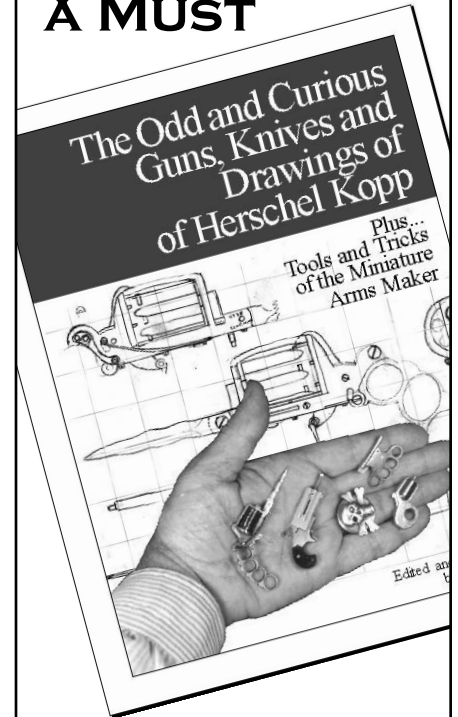

Here's a chance to see the beautiful guns, sketches, and writings of one of the founding members of the Society, Herschel Kopp.

This 96 page, soft bound book costs \$20 per copy plus a shipping and handling charge per book of \$4 for USA, addresses, and \$8 outside the USA. Checks made to the Miniature Arms Society, should be sent to

**Alice McGinnis,  
2109 Spring St,  
Cross Plains, WI 53528.**



# News...2012 NRA Show-Pittsburgh



*Above: David Kucer at the MAS booth.*

Hi Bob,  
Here are the photos of this years NRA convention. As usual our booth was a big hit with everyone.

If you look close you can see a picture of Glen Beck, who went by our booth on Saturday. On the right is a photo of me, Phil Schreier, senior curator NRA museum and Jim Supica museum director.

There are good pictures of David's and Zavier's work. Plus pictures of miniatures Wayne brought and some of my guns.

I want to give a special thanks to my loving wife (shown below) for being a big help in setting up , tearing down and running the MAS booth this year. She definitely is a keeper!



*Jim Supica NRA museum director, Phil Schreier, senior curator Ted Campbell.*

Regards,  
Ted Campbell



*Above: President Wayne Driskill and Zavier Kucer in a serious discussion at the MAS booth.*



*Above: a hard working Mrs. Ted Campbell, keeper of the MAS booth.*



# Silver Medal Winners

This years crop of NRA Silver Medal winners for miniatures was unusual for two reasons: all were presented to Ted Campbell, and a non firearm won a medal.



For the first time, a medal was awarded to a non gun, when it was given for this Al Osterman mini rifling machine.

Medal # 76 was for a 1/6th scale rifling machine by Al Osterman. Circa 1989. The rifling machine is pictured in "The Art of Miniature Firearms" book on page 318. This might be the first item given a silver medal that wasn't a fully completed firearm. But this piece is an exceptional item that the judges truly liked.



Medal # 77 is for a beautiful 1/3rd scale Remington O/U Derringer made by David Kucer.

Medal # 78 is for a Marlin 1893 rifle in very small scale. Made by a unknown jeweler from Buffalo New York. It is also pictured in the book on page 247. Thanks to Bob McGinnis for making the oil can

*continued...*





Above: Ted Campbell and Ted Campbell and Ted Campbell accepting Silver Medals.

that is in perfect scale for this gun. It is hard to believe that the to unscrews!

The winner of the NRA trophy cup (The big award) was won by "The American Thompson Association" for their display titled "The Evolution of the Sub-Machine Gun". Below is MAS member Tracy Hill and the gang winning that trophy.

Regards,  
Ted Campbell



Above: Tracy Hill accepting the NRA Trophy cup for the American Thompson Association.

## Miniature Western Al Shelton Holster



Hi Bob, I thought you would like to see my neat little Western holster made by Al Shelton. This holster is hand carved with incredible detail to scale and the stitching is really amazing. It is just under 3" long. It has Al's stamp on the back which says "HAND MADE BY AL SHELTON - LEATHER ARTIST STUDIO CITY - L.A. CALIF."

Al is known as cowboy artist to the stars. His work is collected by many Hollywood celebrities including Tom Sellack, Gene Austry, President Ronald Reagan and many others.

He started doing leather work in 1943. He worked for a short time with Rowell's Saddlery. After that, he took a job with Ed Bohlin. Al learned from and worked for some of the top names in leathercraft. What also makes this miniature holster neat is it is dated on the back, "1963". This is a perfect addition for one of those 1/5 scale silver Kopp - Baez Colt single action army.

I'll send more stuff soon.

Regards, Ted Campbell

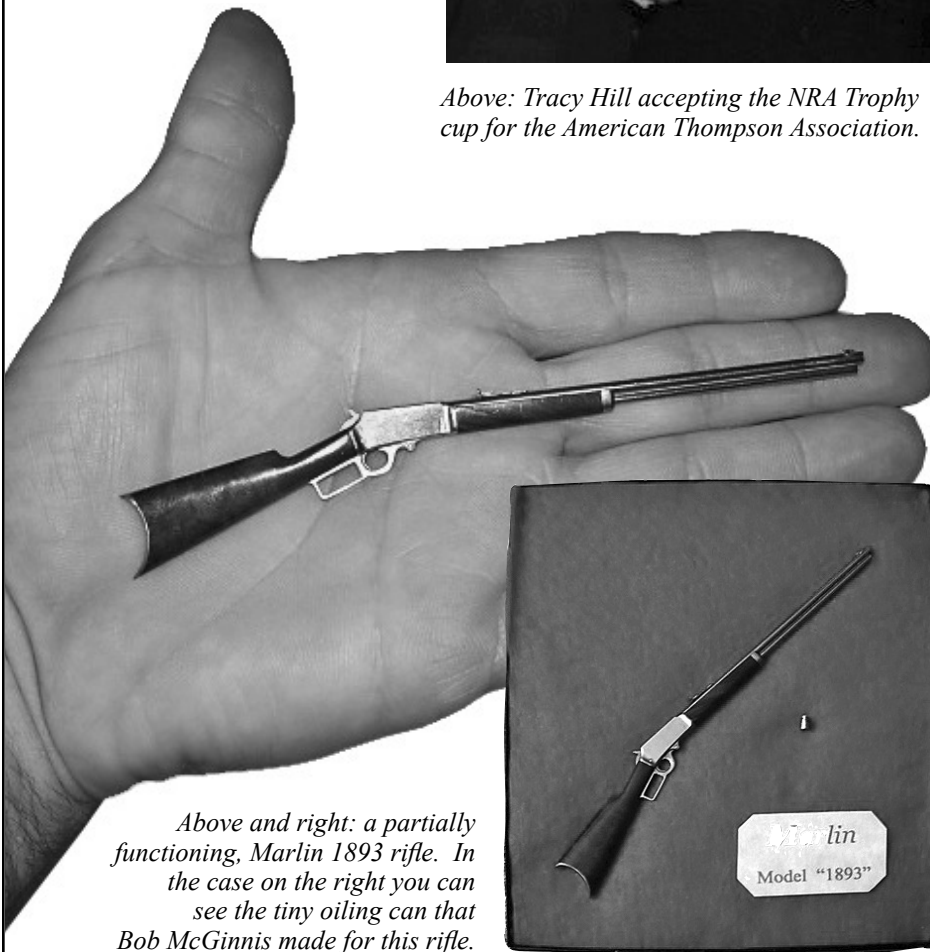

Above and right: a partially functioning, Marlin 1893 rifle. In the case on the right you can see the tiny oiling can that Bob McGinnis made for this rifle.

# A GORDON HEASMAN REVOLVER

BY:  
BOB  
URSO

Recently, member Ron Olsen sent me this interesting revolver to see if I could get the double-action working again. In talking to Ron on the phone, I learned that it was made by noted English miniature gun maker Gordon Heasman, and it appears on page 192 of "The Art of Miniature Firearms."

The problem was a bent hand that kept catching, preventing the hammer from traveling back far enough to release from the sear. A simple fix.

In taking the gun apart, I was very impressed with the clean finish, and sharp edges. The machining was so well done, that little finishing with sandpaper seemed necessary, thus preventing the edges from rounding off.

On this page are several photos I took while the gun was in pieces. On the bottom left, we can see the gun and parts shown actual size. VERY IMPRESSIVE! On the lower right are the parts shown enlarged, so you can get a better look at the accuracy of the detail.

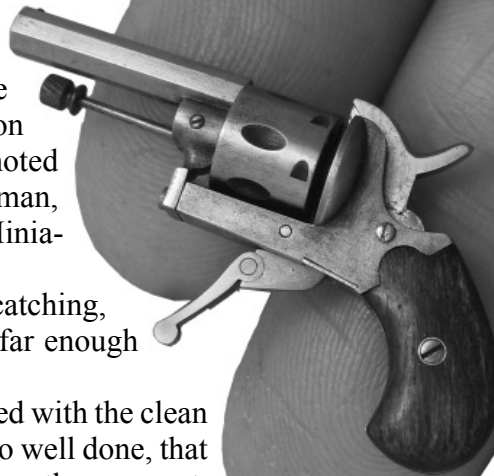

*Above: the parts shown actual size.*

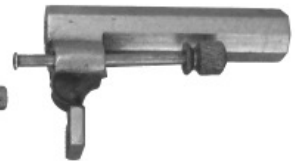

*Here are the parts shown enlarged 100%*



# Miniatures From The Whichard Collection

## Part 3 - Flintlock and Percussion Pistols

Here is the third installment of guns from the Ken and Coral Whichard collection. After spending three days shooting photos, of the bulk of the collection, in September of 2011, I am finally finished, editing, silhouetting, and retouching the photos. In this issue we are featuring the pre-cartridge, flintlock, and percussion hand guns. The quality of the collection is obvious when you look at the photos of the pistols, and the names of the makers. Only the best. Kucer, Hutchens, Stanek. Enjoy, and we will have much, much more in issues to come.



*Above: a 1/3 scale Scottish, all metal pistol, cased with accessories, made by Stanley Blashak. OAL 5.5in*

### Bob Urso

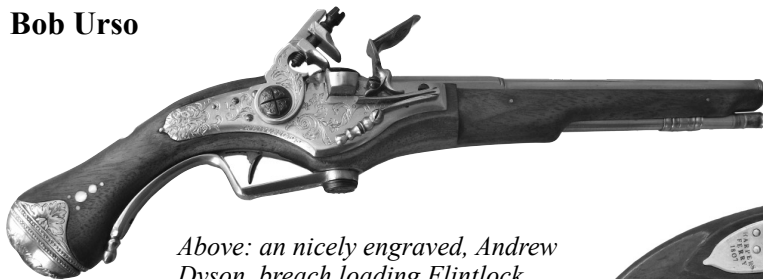

*Above: an nicely engraved, Andrew Dyson, breach loading Flintlock, OAL 7-7/8"*

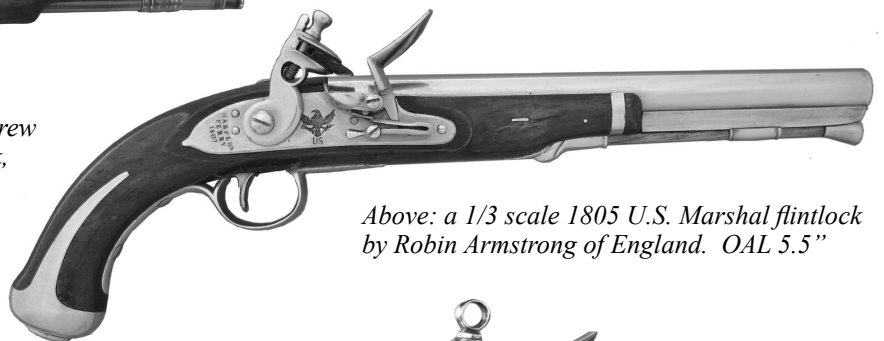

*Above: a 1/3 scale 1805 U.S. Marshal flintlock by Robin Armstrong of England. OAL 5.5"*



*Above: Shown actual size is a 1/3 scale flintlock by Gordon Heasman. It is the gun shown on page 192 of the MAS "The Art of Miniature Firearms" book.*

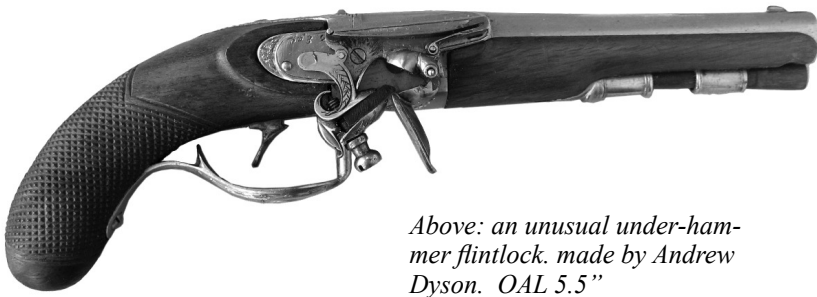

*Above: an unusual under-hammer flintlock, made by Andrew Dyson. OAL 5.5"*



*Above: shown actual size, a 1/4 scale Tap-action over and under flintlock cased with accessories, by J. Giles.*

*Below Right: 2/5 scale flintlock, model 1731 Prussian Cavalry Pistol by Gilbert Ball. OAL 9.5"*

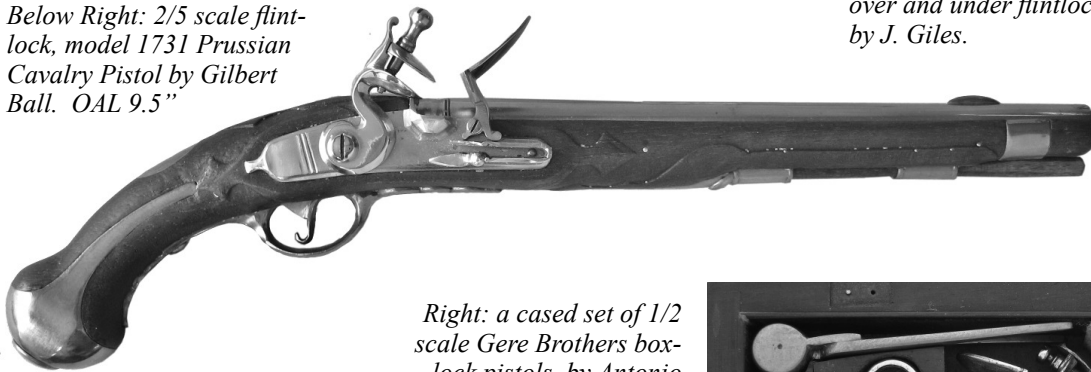

*Right: a cased set of 1/2 scale Gere Brothers box-lock pistols by Antonio Rincon of Columbia. OAL 3.5"*



*Right: Shown actual size, a one of a kind, John Cooper 1/4 scale Box-lock folding trigger pistol with screw off barrel.*



*Left: Rare for any collection, is a John Cooper pistol. (shown actual size) a 1/4 scale Flintlock Pistol. This was the only one of this pistol that John made. Below is the pistol shown enlarged.*



*Right: a cased set of 1/4 scale 1798 Boutet dueling pistols, with a large assortment of accessories, by Antonio Rincon of Columbia. OAL 4"*



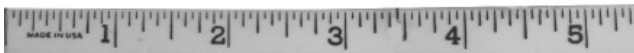

Above: two views of Flintlock self-loader by Andrew Dyson. Note the belt loop, nice engraving, and wire inlaid stock. OAL 5.5"



Above: a set of 1/3rd scale blunderbuss flintlock pistols by Stanley Blashak. OAL 4.75"

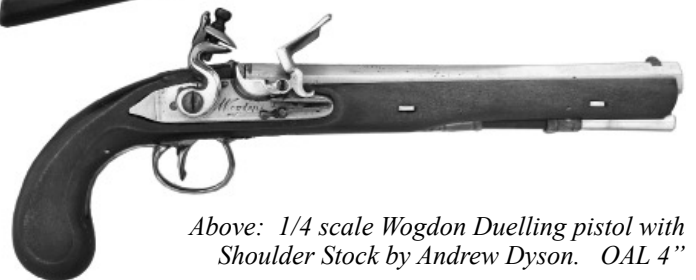

Above: 1/4 scale Wogdon Duelling pistol with Shoulder Stock by Andrew Dyson. OAL 4"



Above: 1/2 scale Brescia (Italy) Snaphance Pistol by an unknown maker, formerly in the Sam Weill Jr. collection. OAL 8.75"



Right: a cased set of 1/3 scale Colonial Flintlock pistol with rosewood grips by Stanley Blashak OAL 6"



*Right: shown actual size, a tiny 1/5 scale Traveler's Flintlock pistol by Stanley Blashak. Cased with accessories and ivory stock. OAL 3"*



*Below: A trio of Stanly Blashak, ivory stocked flintlock pistols.*

*The first (below) is a 1/4 scale Washington Flintlock with ivory stock. OAL 5"*



*Below: a 1/4 scale Washington Flintlock with ivory stock by Stanley Blashak OAL 5"*



*Below is a 1/3 scale Dutch Maastricht ivory flintlock by Stanley Blashak. OAL 7.5"*

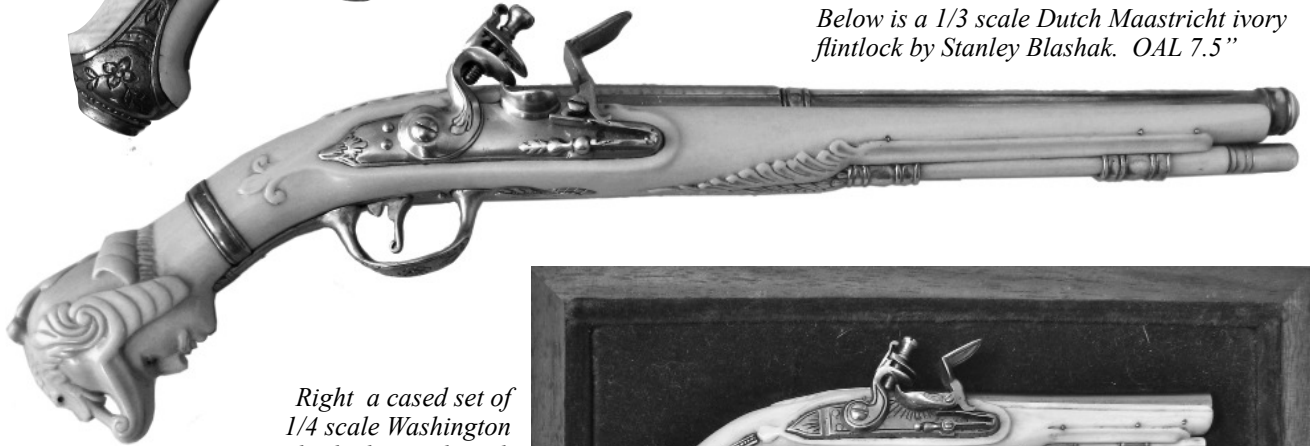

*Right a cased set of 1/4 scale Washington Flintlock pistols with ivory stock by Stanley Blashak OAL 5"*

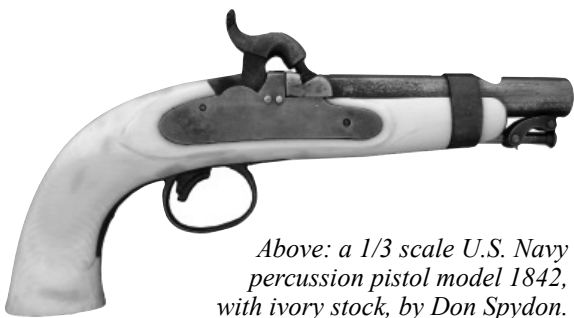

*Above: a 1/3 scale U.S. Navy percussion pistol model 1842, with ivory stock, by Don Spydon. OAL 4 1/8"*

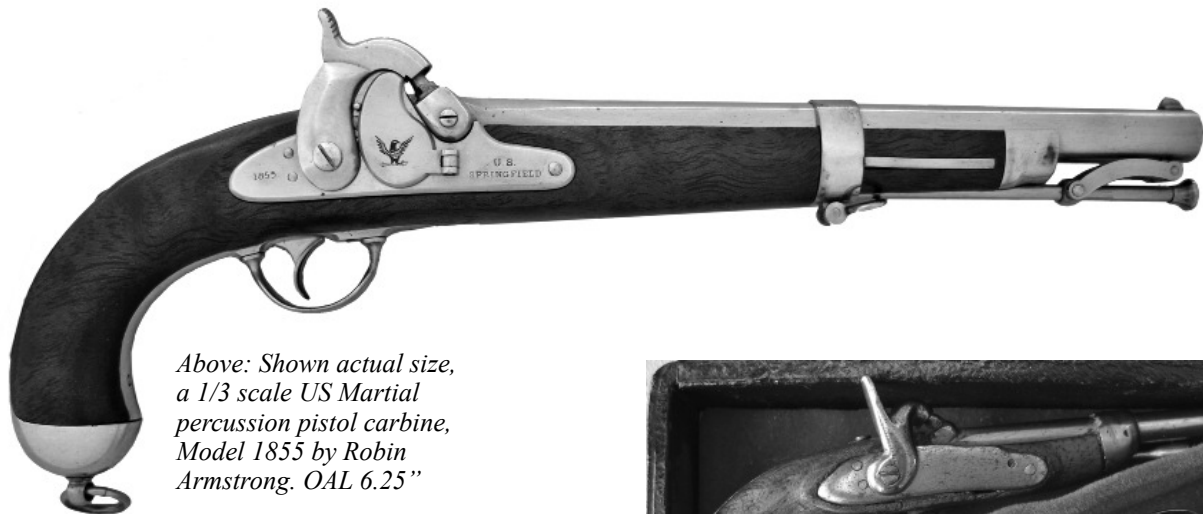

*Above: Shown actual size, a 1/3 scale US Martial percussion pistol carbine, Model 1855 by Robin Armstrong. OAL 6.25"*



*Right: Shown actual size, a cased set of 1/4 scale French Percussion pistols.*

*Right: Shown enlarged, a cased set of 1/5 scale 1845 Jos. Horkom Back-Action percussion pistol by Antonio Rincon. OAL of each pistol is 2-7/8in.*



*Below: 2/5 scale Model 1817 German Percussion pistol - Converted from Flintlock - with shoulder stock made by G. Ball. OAL pistol 5-7/8" with stock OAL 10"*







Above: This is not a miniature, but a small, antique Tap-Action percussion pistol, cased with ivory accessories in a leather bound book. OAL pistol 3-7/8"

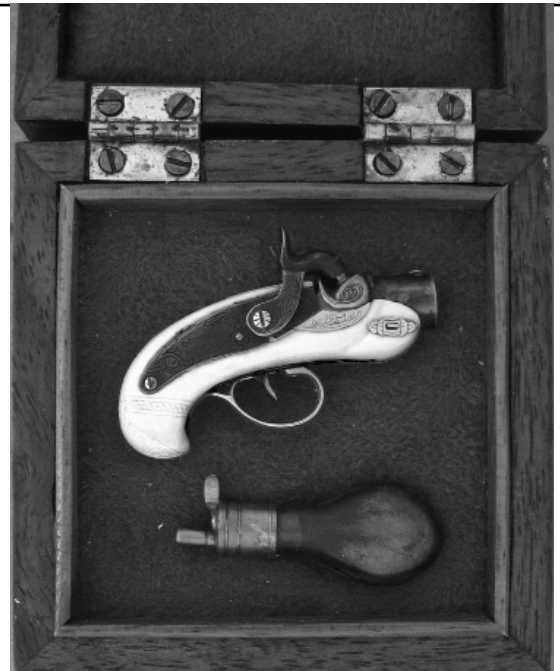

Above: Shown actual size, a 1/3 scale Phila Deringer with ivory stock by Bob Urso. Cased with powder flask. OAL 1-5/8"



Above: Shown actual size, a 1/4 scale underhammer percussion pistol with ivory stock, by Ron Dewalt. OAL 2.5"

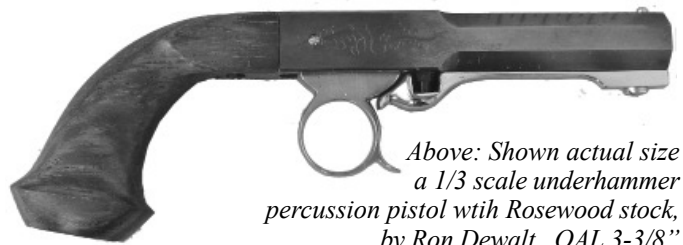

Above: Shown actual size a 1/3 scale underhammer percussion pistol with Rosewood stock, by Ron Dewalt. OAL 3-3/8"

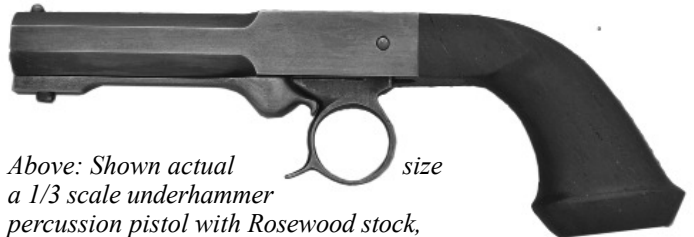

Above: Shown actual size a 1/3 scale underhammer percussion pistol with Rosewood stock, by Ron Dewalt. OAL 3-1/2"



Left: Shown actual size, a cased set of Wogdon Flintlock Duelling Pistols by David Hicks of England. OAL 3-3/4"

# LITTLE ALL RIGHT

## BY BOB URSO

Although not a miniature, the tiny "Little All Right Palm Pistol" has always intrigued me. I'm a sucker for odd and curious guns, and the grip-less profile of this pistol, along with the fact that the trigger is at the top of the barrel, making it a "squeezer" or palm pistol, certainly puts it in that category.

The Little All Right was patented by Edward Boardman and Andrew Peavy in 1876. On the top of the barrel is a slotted tube which holds a sliding trigger. The trigger folds down over the front of the barrel, acting as a muzzle cover, when is not in the firing or "pull" position. To fire the revolver you hold it in the palm of your hand, the end of the barrel resting on

the second finger, the forefinger being placed around the "pull" that, when pulled back, fires the revolver.

There are no markings on the frame other than a serial number. The hard rubber grips are marked "LITTLE / ALL / RIGHT / PATENTED / JAN'Y 18 / 1876" on the left and "ALL RIGHT FIREARMS / CO. / MANUFACTURERS / LAWRENCE / MASS. / U.S.A." on the right.

The gun fires .22 caliber rimfire cartridges, and is double action. Each pull of the trigger rotates the cartridge into position, while pushing back the hammer and

releasing it. The gun below was recently offered for auction and described as follows.

Very fine with approximately 75% of the original nickel finish remaining with some minor frost and some minor flaking. The cylinder is void of finish and has turned a brown patina. The grips are excellent with a few minor dings. The raised lettering is clear and crisp. Mechanically needs work. It sold for \$2500.

On the right is the original Boardman and Peavy patent.

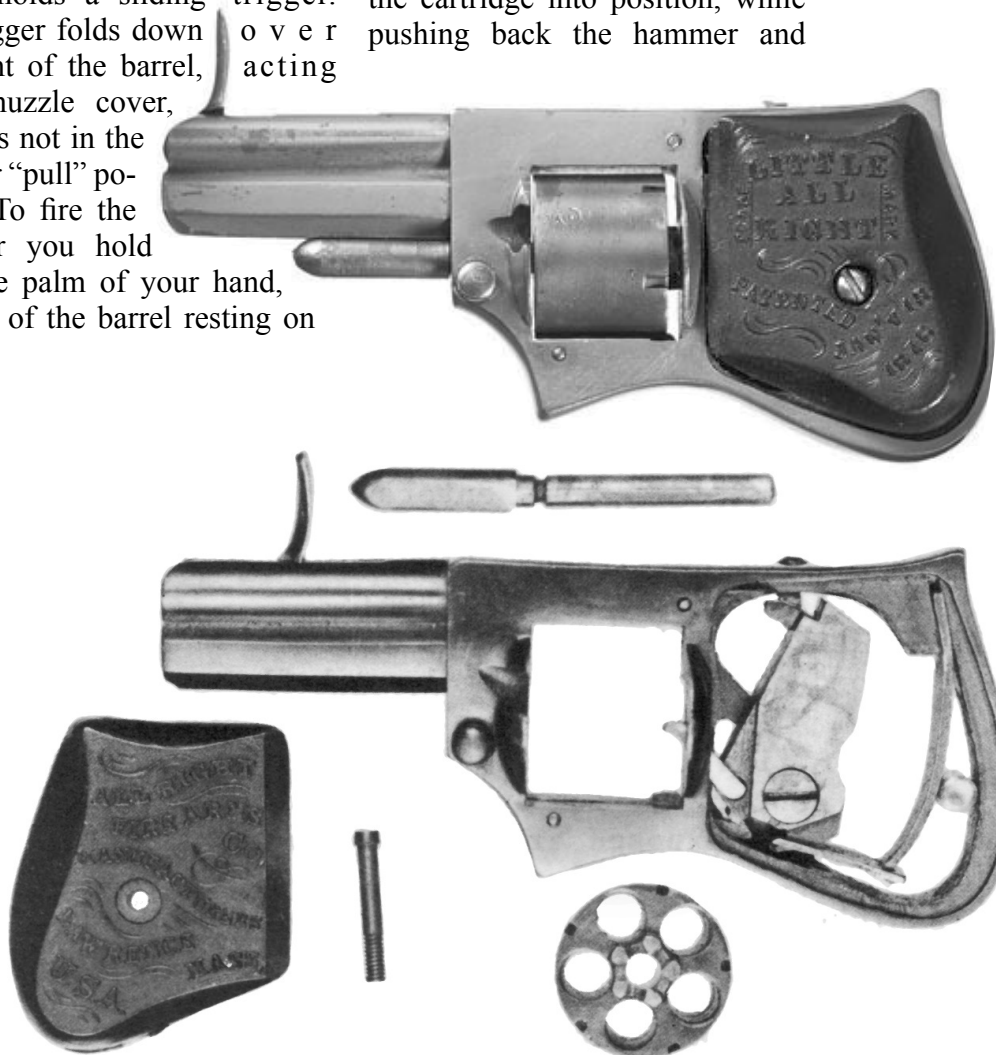

*Photo's left and below show the Little All Right actual size. The barrel is 1.75" long.*

*Left: a good view of the double action firing mechanism of this gun.*

*The .22 caliber, rimfire, five shot cylinder must be removed from the gun for loading, by pressing the button on the lower left of the frame which releases the cylinder retention pin.*

E. P. BOARDMAN & A. J. PEAVEY.

REVOLVING FIRE-ARM.

No. 172,243. Patented Jan. 18, 1876.

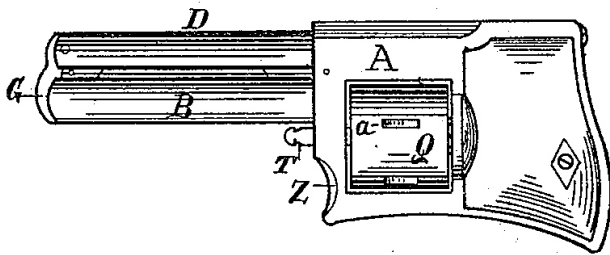

Fig. 1.

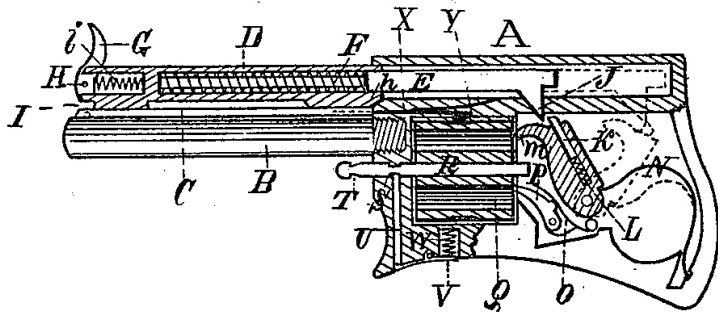

Fig. 2.

*Witnesses;*  
*Levelsobham,*  
*Affect Davis*

*Inventor;*  
 Edward P. Boardman,  
 Andrew J. Peavey,  
 Per C.A. Shaw,  
 "Atty."

If you compare the original design as shown in the patent drawing, with the action of the production model, you'll note several important improvements. First of all, the hammer was redesigned to have more heft, making sure that it had enough striking force to ignite the rimfire cartridges. The spring design was also modified to change the direction of its tension, and also so that a thicker, stronger main spring could be used. Finally the cylinder pin release button is missing in the original patent drawing.

All in all a rare, and very interesting firearm. The only thing better would be a mini. Half scale maybe?

**Bob Urso**



Above: a view of the trigger folded down over the muzzle. This would prevent it from catching on pockets, etc when concealed. Below is a top view of the trigger in the ready to fire position.

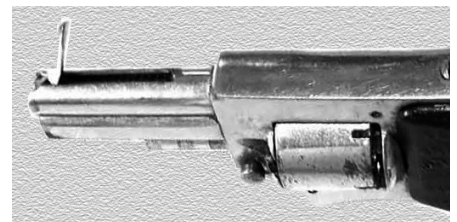

## LITTLE ALL RIGHT PISTOL

Squeezer pistol  
 Weight: 8 oz.  
 Barrel Length: 1.875 inches  
 Capacity: 5 shots  
 Caliber: .22 rimfire



PISTOL



USA

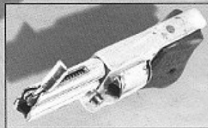
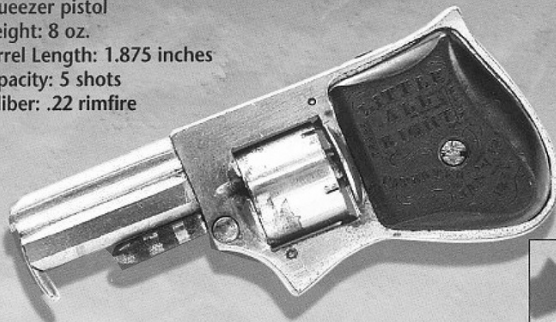

The Little All Right Pistol is an oddity in the category of palm- or squeezer-type pistols. Originally classified by the Bureau of Alcohol, Tobacco and Firearms as a "curio and relic," the Little All Right is now declassified and considered an "antique." Inset shows the trigger turned up for firing.

On the left is the Little All Right featured on one of the cards in a set showing a select group of interesting firearms.

# Antonio Rincon Garniture Set



This garniture was made by Antonio Rincón of Columbia, at 1/3 scale. It is based on a magnificently cased five-piece garniture of gold-mounted arms by the premier arms maker of early 19th century France, Nicolas-Noel Boutet of Versailles, comprises one carabine, two pairs of pistols, with an assembly of tools and accoutrements, and bear five extraordinary paper labels noting presentations of other Boutet arms by Premier Consul Bonaparte in 1803 to Don Federico Gravina y Nápoli ( 1756-1806 ), Don Federico Moyua, Captain of the San Telmo; Captain d'Spinola of the San Joaquin, Don Diego Butron y Cortés, Capitan of the Vigilente; and Captain Castillo of the Nuestra Señora de la Atocha.







The 6/16 inch polished steel round barrels of approximately .18 caliber, each engraved with three bands of roundels, floral swags, dots and meandering line work are finished with individual bands of drapery and "dot and diamond" moldings around muzzles and both the barrels, with polished steel box-locks engraved, in the manner to the Holsters Pistols, with hunting scenes of birds, dogs a standing Lion, a representation of Napoleon who was being referred in the French press as a young lion, standing ready to defend his territory, and a whimsical monkeys playing musical instruments in the manner of Jean Baptiste Oudry, and inscribed on top plate behind the pan, Boutet Directeur Artiste, each lock jaw

engraved with a donkey's head, concealed triggers, each burl walnut bag shaped stock set with 34 high relief gold studs pique along the exterior edges of the grips, the studs themselves outlined with gold wire forming an enclosure for two engraved gold embellishments (4 per pistol) of mythological wyverns, or sea serpents, breathing fire; along the back straps of each stock are inlaid seven engraved gold panels alternating between motifs of diamonds and spider webs of 16 vanes, two motif themes which appear throughout the garniture's ornamentation including the spider-web design of the case's silver plaque.

**Antonio Rincon**

## Complete MAS Plans Library Available on CD

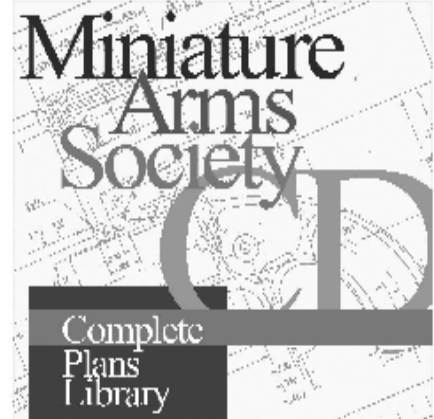

**300 hi- res images** on one CD rom, There's lots of drawings including pinfire pistols, simple derringers, and Colts revolvers Lugers. and a good group of cannons.

The Price is a bargain \$40 per disk PLUS SHIPPING. For more information contact Carmen Gianforte at tel 423-559-1546 or by email at [cjgin40@gmail.com](mailto:cjgin40@gmail.com)

**PLEASE** let Carmen know which version of **WINDOWS** you are using.

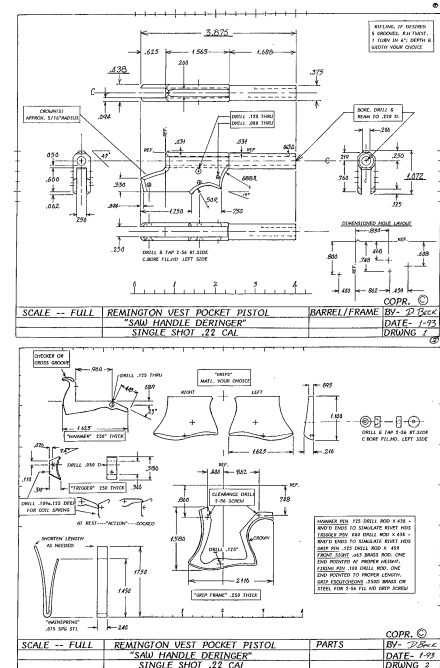

# A JOS. CHILDS MINI-PERCUSSION BOXLOCK

I am not much on or talking about myself but Bob asked me to send a few paragraphs about this mini. First of all I started collecting right after I graduated college in 1968. There weren't many collectors or dealers at the time, just me Jerry Trailins, Hersh Kopp and Dick Young. I am the only one left.

Over the years, I've handled maybe a thousand fine quality minis and collected a good deal of information on minis. I tracked them down wherever they might be, at gun shows, from pictures in articles and books.

Fore quite some time, the bible for miniature arms collectors was a single chapter in the book *Firearms Curiosa* written in 1948 by Lewis Winant. On the last page of the section on miniature arms was shown, and written about, this mini.

I contacted the person named as the owner of the Jos<sup>H</sup> Child mini, and was pleased to know that since 1948 it has been in his collection, and he still owned it. That was 1968, and I bought it from him for \$250.00. Years later, I sold it, to who I don't remember, but when I saw it in the recent Poulin auction I decided to get it back. Because of the large number of miniatures for sale, and the length of the auction, there

were many bargains, and I managed to buy it for 350.00 or 400.00... not bad for almost 50 yrs later.

**Ron Weingarten.**

**ED.** After Ron received the Jos<sup>H</sup> Child mini, He found the spring was weak, so he sent the gun to me to look it over. Since I jump at the chance to take apart antique minis I said yes. As it turned out, someone tried to fix a broken mainspring by splicing on a small thin spring with a plastic band. On the bottom of this column is a photo of the two springs with the new spring I made on top, and the old spring below it. In addition, made a fitted lining for a case he'd found.

**Bob Urso**

*Left: The Jos<sup>H</sup> Child pistol shown enlarged.*

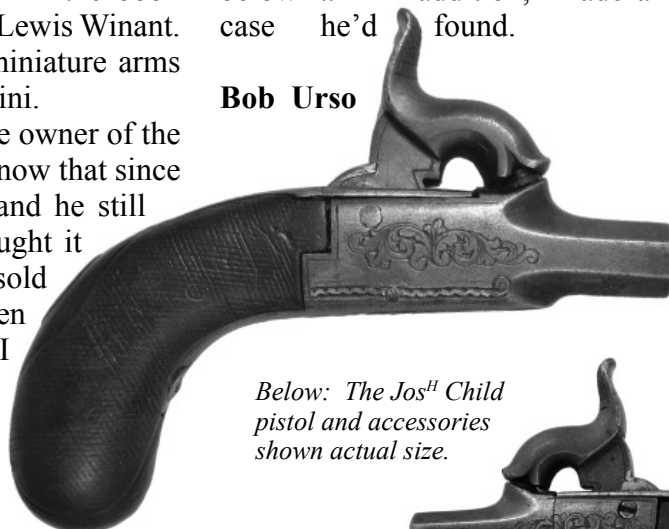

*Below: The Jos<sup>H</sup> Child pistol and accessories shown actual size.*



*Above: This is as far as I was willing to go in taking the pistol apart. The side piece does come out, but the tiny screw that held it in place was just too fragile for me to attempt unscrewing it.*

*Above: is a photo of the new spring I made, and below it, the old, broken spring, which someone tried to repair by using a plastic band to attach a piece of thin spring. It did hold tension on the hammer, however it wasn't strong enough to snap the hammer with any authority.*

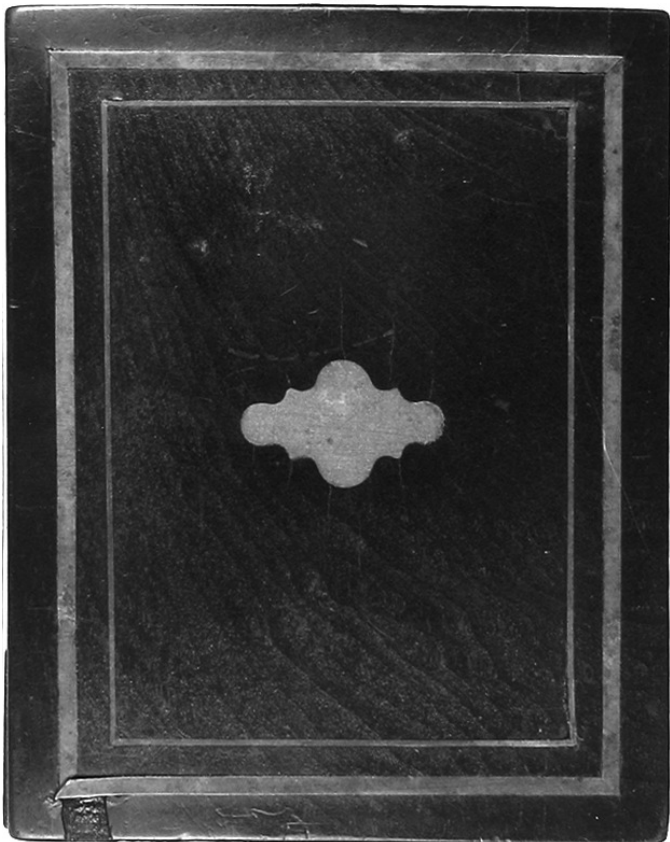
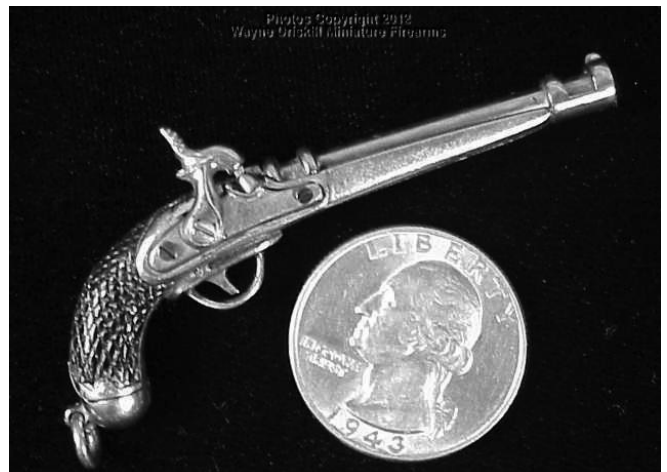
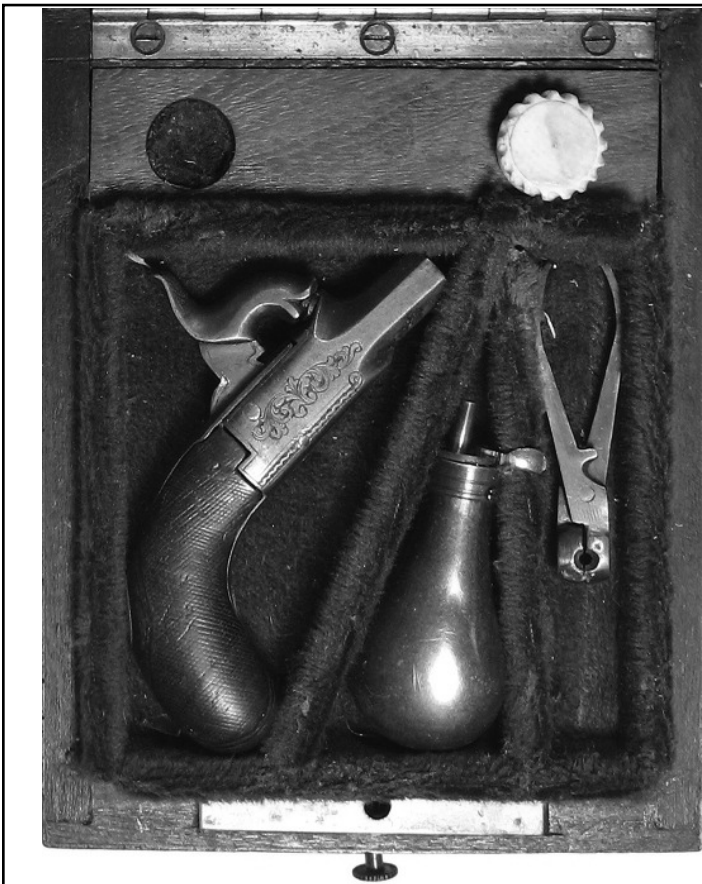

*Above: the re-fitted Antique case.*

*Right: a close up of the barrel proof mark.*



## An Undiscovered Balogh?

This is what I believe to be an undiscovered Balogh 18K yellow and white gold percussion pistol, as it is not shown or mentioned in Bob Urso's book, *"The Tiniest Guns"*. 2.455" long overall with a 1.4" barrel. The stock is 18K yellow gold with finely checkered grip and some additional checkering on the bottom of the forearm. All other parts are 18K white gold.

The action is functional. Unlike the other Balogh miniatures I have had in the past where the whole trigger-guard was pulled to release the hammer, this one is much more finely made with a functional trigger. Weighs .6 ounces, so with gold at \$1,560.00/ounce today, there is \$702.00 worth of gold in this miniature.

**Wayne Driskill**



**The Silver Mini Flintlock** shown below was offered at a recent Stevens Action with little description except *partially functional*.



**Found on Ebay**



This is a magnificent late 19th century French hand made sterling silver miniature model of a pistol; with a wonderful detail, design and workmanship. It was purchased in Paris 50 years ago. No hallmark or signature. It measures 5.25" front, 2.2" tall and 0.55" wide. It weights 0.75 ounces or 23.8 grams.

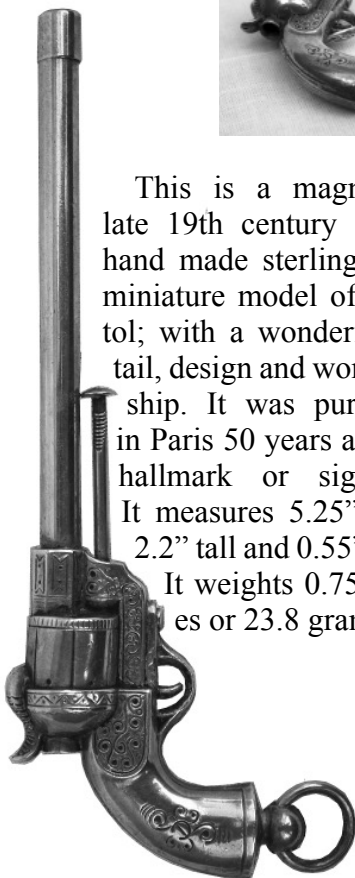

## A Unique Forsyth System Ring Gun?

Well, here's something I've never seen before! A 5 shot ring gun on the Forsyth System. Instead of using the normal 4mm pinfire cartridge, or being percussion, this one is pellet primed, or a pill lock. A pellet of mercury fulminate is inserted into each cavity on the back side of the cylinder. A lead ball of .130 is inserted into each cavity on the circumference of the cylinder. The pellet of fulminate is both the priming mixture and the powder to fire the ball. The pellet of fulminate explodes when hit by the hammer.

The ring looks to be silver, and is engraved "SYSTEM FORSYTH" on the back side along with some decorative stem & leaf. The steel parts are fire blued and retain about 85% original thinning finish. The inside of the ring measures .820. The cylinder is .500 in diameter and .284 long. Uses the same type trigger release on the side as the 4mm pinfire type ring guns. Includes a hinged top brown leather casing with hook latches. The lid inlaid with a silver oval that is engraved "SYSTEM FORSYTH". The interior French fit and lined in a dark brown felt. There are two compartments, but both are empty. One probably for the screwdriver to remove the cylinder, the other maybe for the pellets and lead balls.

Truly unusual!

**Wayne Driskill**



## Xu Yan's shop is small like the guns he makes.

**ED.** Xu Yan is a MAS member from China, who's shop is described below by his daughter.

Given our income and limited space, it is impossible for my father to have a separate workshop. His "workshop" is a reading desk in the corner of his bedroom, and sometimes, the balcony of our apartment. He stores his various tools in the cabinets on both sides of his desk. Generally speaking, his tools are simple. However, he also possesses a large number of miniature tools for accurate operations. He also has several microscopes and other magnification

In order to make some of the small parts he needs, Xu Yan built a milling machine of his own design from various components.

His lathe - shown below - is a D-bed watch maker or jeweler's type lathe to which he has added a stereo microscope for doing very small work. The reversible tailstock has a drill chuck on one end and a dead center on the other. Work is driven by a larger drill chuck in the headstock.

Mr. Xu has upgraded his shop capabilities by creating a more

powerful and versatile milling machine. He notes that he assembled the milling head using a 180 watt motor that will turn to 10,000

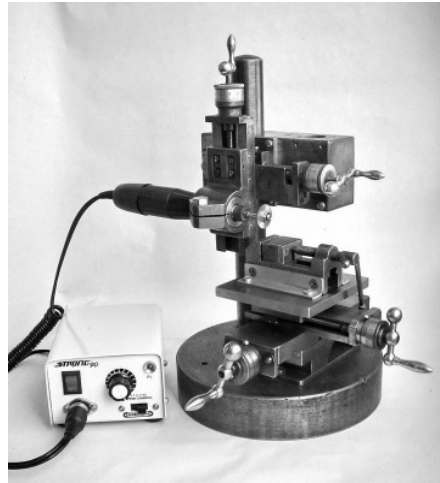

RPM. (above), it includes a speed control switch and a pulley system that runs the spindle at up to 5000 RPM. The head can be used in the vertical or horizontal position.

Some of the magnification tools Mr. Xu uses to help him do the very small, detailed work necessary to produce parts for his small guns. The photo to the right, shows his setup for viewing very small drilling work. He also uses a small X-Y table under the drill head for positioning parts for accurate drilling.

The tools used are not high tech. Here is a selection of pliers and other tools used to make the small parts for the guns.

High speed grinding burrs are also used. A large selection of tip shapes are at Mr. Xu's disposal.

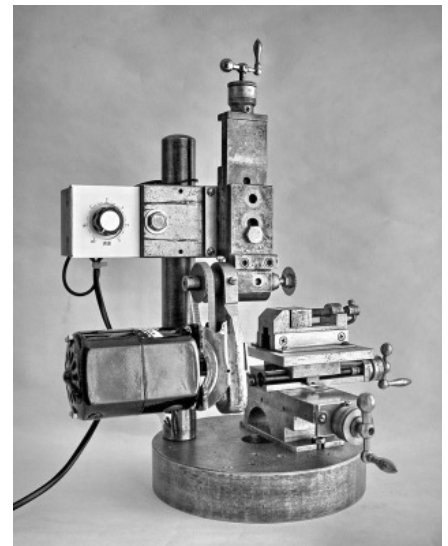
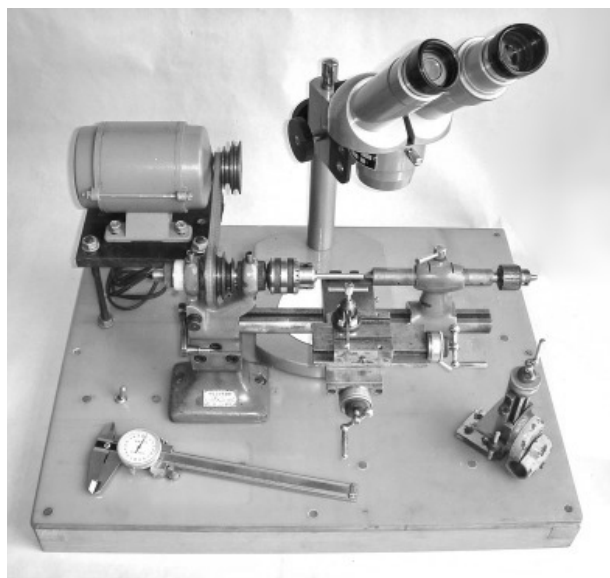

# AUCTION HIGHLIGHTS

On these pages are a group of miniatures that were recently up for auction at Rock Island Auction house.

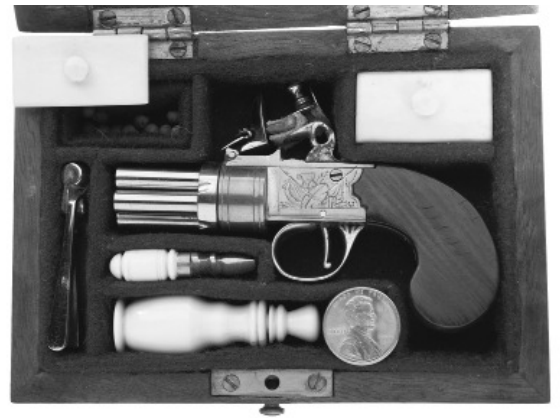

*Lot 107 3 3/4 inches overall, with a 6-barrel cluster; a single in-line hammer and flash pan installed on the brass frame, engraved arrays of arms on each side, and a smooth bag shaped grip. With a green felt lined hardwood case, bullet mold, ivory handled screwdriver, ivory oil bottle and a pair of compartments with ivory lids.*

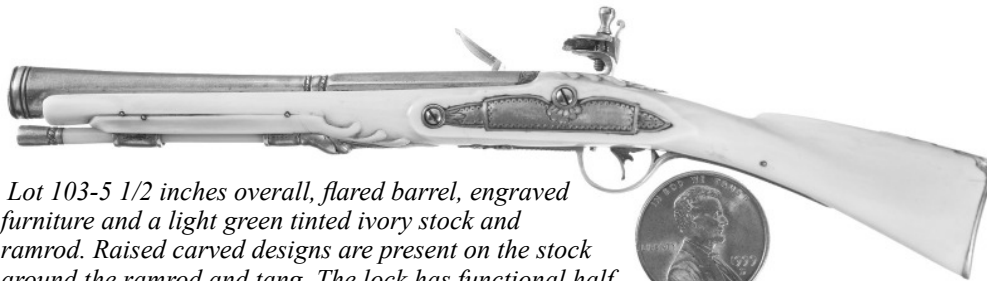

*Lot 103-5 1/2 inches overall, flared barrel, engraved furniture and a light green tinted ivory stock and ramrod. Raised carved designs are present on the stock around the ramrod and tang. The lock has functional half and full cock positions.*



*Lot 104 - Produced without sights, with a hand engraved King George cipher under the flash pan and an illegible mark behind the hammer. Full stock, with ramrod and brass fittings. In a leatherette case marked "Weingarten's Ltd/157,/Bishopgate,/LONDON, E.C.2." inside the lid.*



*Lot 112 Pin front sights, with "-L.H. SMITH-" on top of one barrel, the Wesson address on the left, and a 5/8 inch pistol bayonet in the center. Niter blue barrel group, hammer and trigger, with smooth birds head grip. In a green felt lined hardwood case with a cleaning rod and 8 dummy rounds.*



*Lot 108 Measuring 1 1/4 inches overall, with a niter blue hammer and trigger, scroll and punch dot engraved frame, "L.H. SMITH" on the bird's head butt and smooth ivory grips. In a hardwood case with a cleaning rod and a set of 10 inert rounds.*



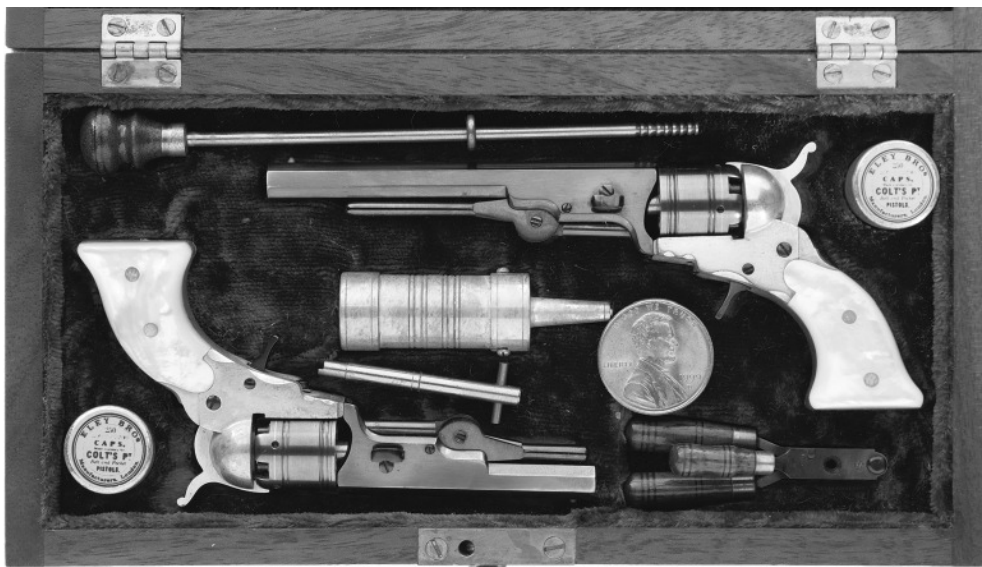

*Lot 106 Marked “-L.H. SMITH-FLA.-USA-” on top of the barrel, with fire blue barrel, cylinder and trigger, silver finished frame and grip straps, and riveted pearl grips. In a red velvet lined hardwood case with cleaning rod, nipple wrench, bullet mold, silver powder flask and a pair of miniature Eley Brothers tins. The triggers do not fold and the cylinders are hand turned. The case is also stamped on the bottom with the serial numbers.*



*Lot 110 Measuring 15 1/2 inches overall, with a blue finish, fluted barrel detachable magazine and shoulder stock. Simulates open bolt operation, with functional safety. Barrel is not bored through.*

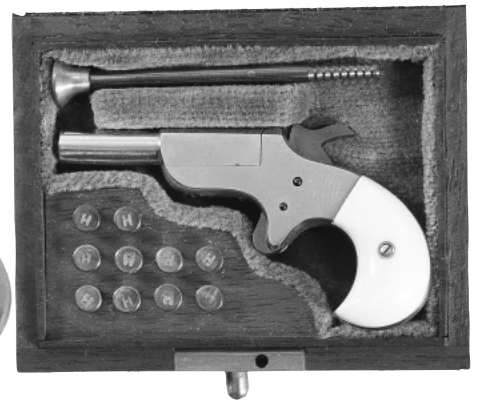

*Lot 118 Produced without sights, with “STAR VEST POCKET” atop the chamber, and “L.H. SMITH” on the birds head butt. With a hardwood case with green felt lining, cleaning rod, 10 inert rounds and a plaque on the lid reading “Best Single/Weapon/Winter Show/C.A.D.A. 1991”*

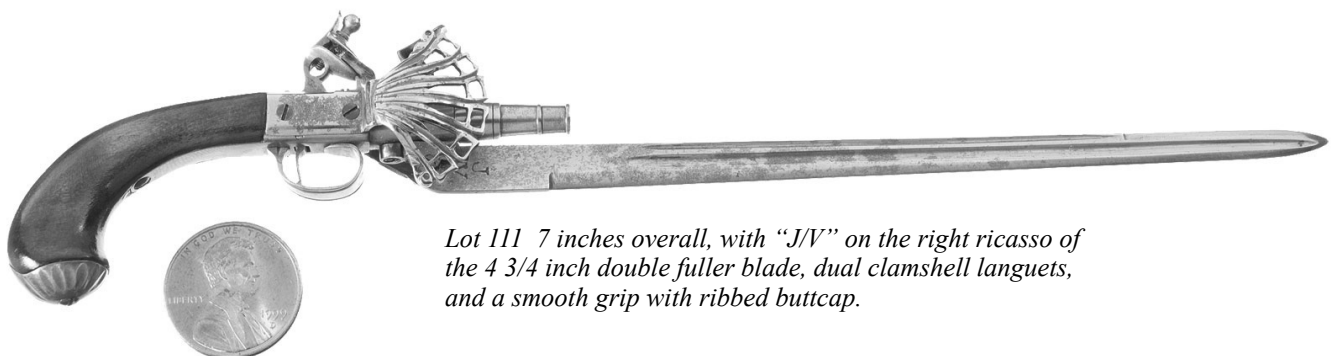

*Lot 111 7 inches overall, with “J/V” on the right ricasso of the 4 3/4 inch double fuller blade, dual clamshell languets, and a smooth grip with ribbed buttcap.*

# Pinfire

## Page

By Bob Urso

All the guns in this month's collection were found on the internet. Some from auctions houses, a couple from dealers. All unusual.



The grips on this Pfannl designed pinfire are of the highest quality, and very unusual. The gun was listed for sale on a French gun dealers website. Unfortunately they would not ship to the USA. Below are the original French descriptions, and an English translation

(4.5 cm) Pistolet breloque miniature à broche à canon basculant et crosse métal ciselée d'un bouquet. Présenté dans un coffret cuir rouge. XIX/XX°

(4.5 cm) pinfire miniature charm pistol with Drop barrel and sculpted floral metal grips. Presented in a red leather box. XIX /XX°

From the same dealer, is this larger pinfire pistol described as:

(12 cm) Petit pistolet à broche. Canon rond basculant avec extracteur. Détente mexicaine. Crosse quadrillée. XIX°.

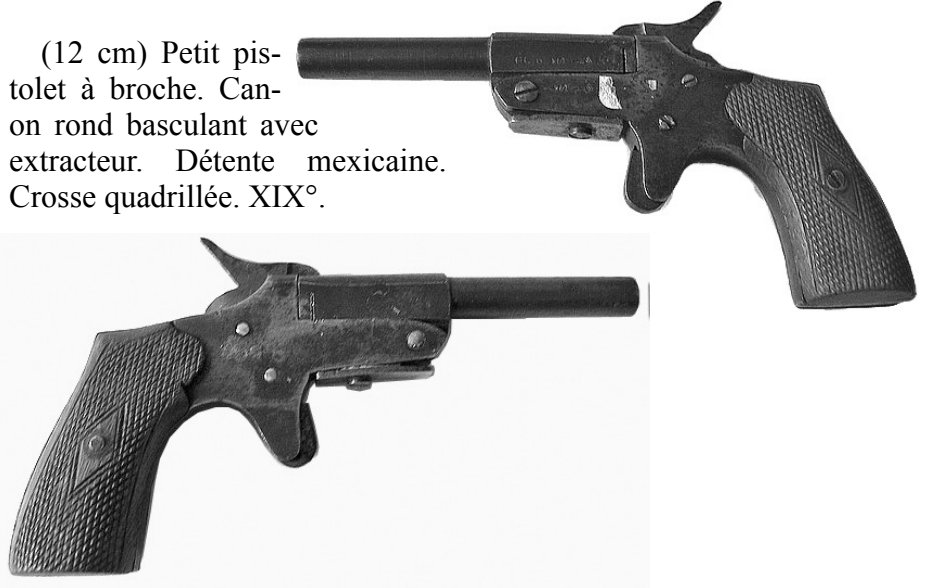

### K. Tabaczkowski

Here's another auction find. It was described as:

A fine miniature pinfire pistol signed on the barrel K. Tabaczkowski, circa 1870. Rifled barrel 4.5cm, overall length 7.5cm.

Engraved at the breech and locked by an engraved stud on the left. Engraved action. Hammer hatched trigger and ivory butt.





## A Czech Pinfire?



This is from a past Hermans Historica auction. The reserve was 250 euro, it sold for 1600 euro. I've included the original German description, and the translation that the "Google" translation software gave me.

Los Nr.825

### Miniatur-Kipplaufpistole,

Tschechisch um 1870. Kipplaufbarer, glatter Lauf im Kal. 2 mm, dünne Brünierung, Schienensignatur "NA PAMTKU". Einfache Laufhakenverriegelung mit rechtsseitigem Verschlusshebel, Verschluss etwas locker, intaktes Hahnschloss, ringförmiger Abzug, feine Arabeskengravur, Perlmuttgriffschalen, Länge 51 mm.

Im zugehörigen, grün ausgeschlagenen Krokodillederkasten mit neuem Behälter für Stiftfeuerkartuschen, Maße 6,5 x 4 x 1,5 cm.

Lot Nr.825

### Miniature Kipplaufpistole,

Czech around 1870. Tilting, smooth bore in caliber 2 mm thin blueing, bar signature "NA PAMTKU". Simple running loose with a right hook latch lock lever, cap a little hammer lock intact, ring-shaped hood, fine arabesque engraving, pearl handles, length 51 mm.

The accompanying green crocodile leather lined box with a new container for pin fire cartridges, measures 6.5 x 4 x 1.5 cm.

Here is a hard to find 2mm pinfire revolver that was made in Germany. It's an "HS Six-Shooter Mod 8". It's described on page 60 of "The Tiniest Guns". The HS stands for Hebert Schmid the designer. If anyone has one, I'd love to add one to my collection.

Bob Urso tel 360 733-4406



## XYTHOS-Präzisions-Kleinstfeuerwaffen aus Österreich



**Xythos-automatic Kipplaufrevolver.**  
Kal. 2 mm, Länge 4 cm  
Gewicht 15 Gramm, alt  
Schlüsselanhänger NN DM 22.-,  
1 x 36 Pack. Patr. NN DM 4.50

### Xythos-Signal-Notausrüstung.

Revolver wie oben, jedoch Spez.-Lauf und Kal. 1 mm, Schießbecher, Set wie oben, in schlagfeste Kassette. Gesamtgewicht 80 Gramm! Immer zu Hand! Ohne Leuchtpatronen NN DM 29.50



**Xythos-Gold-Derringer**, einschüssig, Kipplauf, für Knallpatrone, neuer Abzug am Griff Rücken, Länge 22 mm, 5 Gramm!

An Schlüsselkette und Ring NN DM 16.  
Auch an verg. Armband, Halskette etc. in 25 mod. sehen Variationen.



**Signalgerät SG 277**, Länge 9 cm, für Signalpatrone 6/15 mm, Drehsicherung, abgelenkter Schlagboizen, einmalige Konstruktion, ein PROFIL! Schwimmgehäuse verpackt. Ohne Signalpatrone NN DM 35.

Plus Versandkosten zu den Selbstkosten. Verkauf nur an Personen über 18 Jahren mit Altersnachweis

### OTMAR KROPF

Xythos-automatic-Vertrieb  
Postfach 120  
D-8510 Fürth (Bayern)

Above: a vintage Xythos ad.



# Websites Worth Checking out...

The Miniature Arms Society Site - by Brad Maxfield .....	<a href="http://www.miniaturearms.com">www.miniaturearms.com</a>
Piccolo Miniature Gunworks - Bob Urso's site .....	<a href="http://www.boburso.com">http://www.boburso.com</a>
Joel Morrow's miniature arms site.....	<a href="http://WWW.800MINIATURE.COM">WWW.800MINIATURE.COM</a>
Paul Gauffins has a website "Small Arms Specialists" .....	<a href="http://www.miniguns.com">http://www.miniguns.com</a>
Peter Dyson and Sons, England.....	<a href="http://www.peterdyson.co.uk/">http://www.peterdyson.co.uk/</a>
David Kucers web site is now located at .....	<a href="http://kucers.com/">http://kucers.com/</a>
See Lew Callahan's minis at - .....	<a href="http://home.earthlink.net/~lwcallahan1/lewsminiatures/">http://home.earthlink.net/~lwcallahan1/lewsminiatures/</a>
Robin Armstrongs guns - .....	<a href="http://www.armstrong-miniatures.com">www.armstrong-miniatures.com</a>
Wayne Driskill Miniatures at .....	<a href="http://www.waynedriskillminiatures.com">www.waynedriskillminiatures.com</a>
Google Patent Searches.....	<a href="http://www.google.com/advanced_patent_search">http://www.google.com/advanced_patent_search</a>
George Jones - Model maker, and mini-mini gun maker.....	<a href="http://www.georgewjones.com/">http://www.georgewjones.com/</a>
George Jones - Crossbow book website .....	<a href="http://www.blurb.com/books/1487431t/">http://www.blurb.com/books/1487431t/</a>
Internet Craftsmanship Museum .....	<a href="http://www.craftsmanshipmuseum.com/gunsmiths.htm">http://www.craftsmanshipmuseum.com/gunsmiths.htm</a>
Hiroshi Goto Japanese 1/6th scale miniatures .....	<a href="http://www.7b.biglobe.ne.jp/~kyozan21/">http://www.7b.biglobe.ne.jp/~kyozan21/</a>
German website dedicated to the derringer, with a page of miniatures .....	<a href="http://www.derringer.de/minii.htm">http://www.derringer.de/minii.htm</a>
Miniature Knifemakers/Collectors Society.....	<a href="http://www.miniatureknivessociety.com/">http://www.miniatureknivessociety.com/</a>
Cornell Publications - Reprints of old gun catalogs and manuals .....	<a href="http://www.cornellpubs.com">www.cornellpubs.com</a>
Menefe Consignments site of member Joe Menefe.....	<a href="http://www.menefeconsignments.com">www.menefeconsignments.com</a>
Kimiaki Ohba Miniature guns .....	<a href="http://www.ohbakobo.jp/">http://www.ohbakobo.jp/</a>
Charleston Mini Gun Works .....	<a href="http://www.minipinfireguns.com">http://www.minipinfireguns.com</a>
Jon Hintz miniguns can be found at .....	<a href="http://www.jonhintz.com">http://www.jonhintz.com</a>
Henry Loos mini knives etc. can be found at .....	<a href="http://www.stores.ebay.com/miniature-weapons-by-loos">www.stores.ebay.com/miniature-weapons-by-loos</a>
An excellent Miniature pinfire collection .....	<a href="http://antiquescollect.com/MiniaturePinfirePistols.htm">http://antiquescollect.com/MiniaturePinfirePistols.htm</a>
Pinfire Guns .....	<a href="http://www.pinfireguns.com/">http://www.pinfireguns.com/</a>

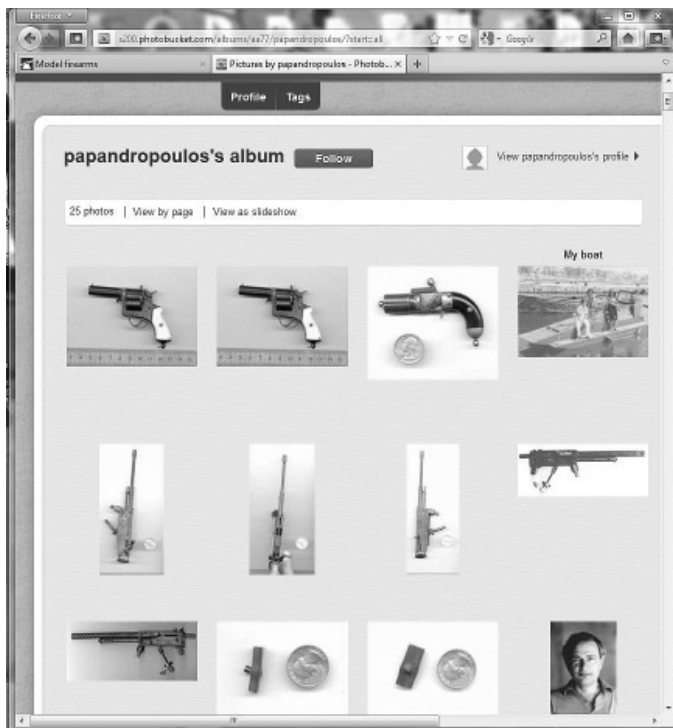

George Papandropoulos, from Greece, who's work has been featured in past issues of the journal, has a nice group of images of his mini's online at <http://s200.photobucket.com/albums/aa77/papandropoulos/>

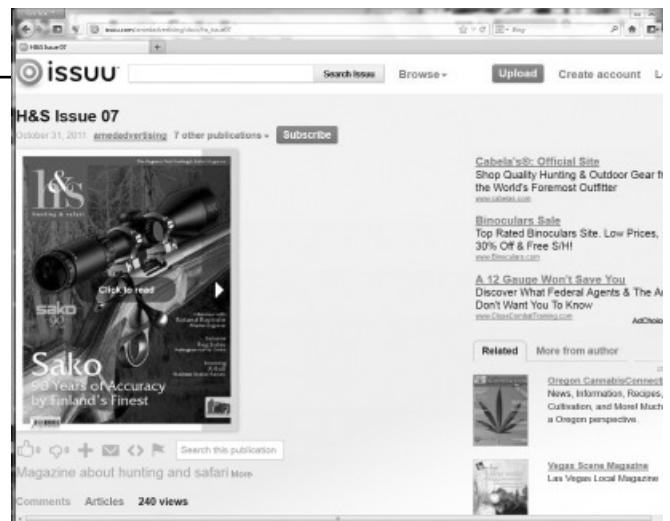

Be sure to check out MAS member Robert Segel's fine article on automatic weapons in *Hunting & Safari* issue 07. It is on line at [http://issuu.com/amedadvertising/docs/hs\\_issue07](http://issuu.com/amedadvertising/docs/hs_issue07) When the page above comes up click on the "Click to Read" button in the center of the cover, then turn the pages until you get to page 65. Excellent article, with great color photos.

If you try to visit a listed site, and the URL is dead, please email [boburso@boburso.com](mailto:boburso@boburso.com), and we'll take it off the list. Also please contribute any interesting sites so you can share them with members.





Below are members email addresses. If your email address changes be sure to email me at boburso@comcast.net

Adrian, Bill ..... MAS-MEMSHIP@msn.com  
 Armstrong, Robin ..... jandr.armstrong@virgin.net  
**Barron, Rodney..... rbarron@pol.net)**  
 Bartram, Barry ..... bbartram1@comcast.net  
 Berwick, Leslie, ..... berrix@xtra.co.nz,  
**Briglia, James Sr.,..... jamescoruette@yahoo.com**  
 Brower, Bailey ..... baileybrower@yahoo.com  
 Brown, Arthur ..... writeous@swbell.net,  
 Brownell III, Frank ..... fbrownell3@aol.com  
 Butler, Dave ..... railspike@centurytel.net  
 Callahan, Lew ..... LWCallahan1@earthlink.net  
 Campbell Sr., Ted ..... tedsuper49@comcast.net  
 Carter, Hugh ..... h.carter@qut.edu.au  
 Caruth, William, ..... firearmsbill\_caruth@gial.edu,  
 Caulkins, Douglas ..... adcaulkins@att.net  
 Chen, James ..... jchen428@aol.com  
 Cochran, Russ ..... russ0916@gmail.com  
 Colman, Gwil..... gwil.colman@talktalk.net  
 Cox, Daniel ..... dymonddan70@comcast.net  
 Cymment, Stewart ..... stewartcy@earthlink.net  
 Day, James Jr..... jamesdayjr@aol.com  
 Driskill, Wayne ..... wdriskill@hotmail.com  
 Dziadosz..... ddzia@charter.net  
 Dyson, Andy ..... andrew@peterdyson.co.uk  
 Dyson, Peter..... peter@peterdyson.co.uk  
**Emrich, Werner E. ....lionel2341@yahoo.com**  
 Frazee, Bill ..... jwfra@netscape.com  
 Fujise, Joe ..... funforsale@aol.com  
 Fulmer, Mark ..... Markusfu@hotmail.com  
 Gerber, Jack ..... drjackgerber@gmail.com  
 Gianforte, Carmen ..... cjgin40@gmail.com.  
 Gianforte, Joanne's: ..... cjgin40@gmail.com.  
 Gillum, Gregory ..... gillum@centurytel.net  
 Good, D. R. .... drntammigood@bluemarble.net  
 Guerra, Juan ..... juanmg@msn.com  
 Hamler, Paul ..... hamlertools@windstream.net  
 Hintz, Jon ..... jehintz@yahoo.com  
 Hoffman, Robert ..... robertlee-09@comcast.net.  
 Holloway, Mark ..... markholloway@centurytel.net  
**Johnson, Bruce.....brucejohnson@yahoo.com.**  
 Jones, George ..... georgepublishing@aol.com  
 Katona, Zoltan..... Barbara\_1287@msn.com  
 Keeney, Charles ..... cakeeney@verizon.net  
**Kelly, Jim ..... jkellymetal@gmail.com**  
 Kimiaki, Ohba..... kimiaki@ohbakobo.jp  
 Kopke, Sterling ..... skopke@cox.net.  
 Kranzusch, Ken .... kkranzusch@industrialspeciality.com  
 Kritser, Sloan ..... toolegg@ls.net

Kucer, David ..... DMKucer@aol.com  
 Kucer, Zavie ..... zedkay@sympatico.ca  
 Lefavre, Michel..... michel.lefavre@libertysurf.fr  
 Loos, Henry C. .... hcloos@comcast.net.  
 Lowe, Gary ..... jglowe@floorboxes.com  
 Macias, Mike ..... mike.macias@fluor.com  
**Maxfield, Dr. Barry.....dimax@frontier.com**  
**Maxfield, Dr. Brad .....maxfield@mcw.edu**  
 McGinnis, Alice ..... mcginnr@chorus.net  
 McGinnis, Bob ..... mcginnr@chorus.net  
 McHenry, Pat ..... restoreit1@comcast.net  
 McManis, Charles ..... cemcmly@gmail.com  
 McMillen, David, R. .... davidr@mcmillenarch.com,  
 Mpcpee, Russ ..... rmpcpee@rivernet.net  
 Mele, Mal ..... mal@airmail.net  
 Menefe, Joe ..... josephmenefe@yahoo.com  
 Mahmoudian, Moe..... moemahmoudian78@yahoo.com  
 Mpcpee, Russ ..... rmpcpee@rivernet.net  
 Missimer, Jerry ..... jers.guns@comcast.net  
 Morris, Wayne A. .... turo64@gmail.com  
 Morrow, Joel ..... MINIGUNS@COMCAST.NET  
 Mosrie, Rateep ..... teeper1@verizon.net.  
 Nelson, David ..... davidn4329@aol.com  
 Newcomer, Aaron ..... aaronksu@gmail.com  
**Norstrand, Allan.....allannorstrand@hotmail.com.**  
 Ohba, Kimiaki..... kimiaki@ohbakobo.jp  
 Olsen, Ron ..... rono438@aol.com  
 Pentelow, Lynn ..... lpentelow@embarqmail.com  
 Phillips, Ronald ..... BartsArt@BellSouth.net  
 Ronnie, Roger ..... rronnie@knology.net  
 Sampson, Roger ..... sampsonroger@ymail.com  
 Shutt, Bob ..... sbobs63@hotmail.com  
 Snowden, Chuck ..... CLSnowden@aol.com  
 Staines, Derek ..... CARP6218@aol.com  
 Takiguchi, Mark, ..... mach05hi@cs.com  
 Karl Toppel ..... Karl.toppel@linde.com  
 Trester, Verne ..... verne.trester@juno.com  
 Urso, Bob ..... boburso@comcast.net  
 Webster, James, ..... jwebs0551@yahoo.com  
 Wegrzyn, Edward ..... ejwegr@peoplepc.com  
 Weingarten, Ron..... doronron1946@aol.com  
 Weinstein, Alan ..... tlviking@aol.com  
 Wenzek, George ..... gwenzek@aol.com  
 Whichard, Ken ..... kwhichard@suddenlink.net  
 Whichard,Coral..... cwhichard@suddenlink.net  
 Williams, Jim ..... jandewilliams@comporium.net  
 Wood, Harley ..... harlestonwood@aol.com  
 Zgodzinski, Ray ..... zgodzinski@att.net

## Fixes & Changes

New members email...

**Jim Kelly..... jkellymetal@gmail.com**  
**Werner E. Emrich.....lionel2341@yahoo.com**  
**Rodney Barron..... rbarron@pol.net)**  
**James Briglia, Sr.,..... jamescoruette@yahoo.com**

# Shop-r-Swap

**Classified** ads from members or non-members, are free. They can be any length - within reason, as long as they pertain to buying, selling, or swapping. A limited number of images are allowed. **Display** ads must be submitted in camera ready or digital form, and must be accompanied by a check (to Miniature Arms Society). Rates are as follows

	Members	Non-Members
1/4 page		25.00
30.00		
1/3 page	35.00	40.00
1/2 page	50.00	60.00
2/3 page	70.00	80.00
3/4 page	75.00	90.00
Full Page		100.00
120.00		
Back Cover	150.00	180.00
Bus.Card	Free	Free
Classified	Free	Free

To place an ad, contact Bob Urso, tel. (360) 733-4406 or via email at boburso@comcast.net

Shop-r-Swap is **FREE** contact Bob Urso to list your items.

## Beretta Latest Urso Pinfire

Here is the latest design in my 2mm pinfire collection. I'm showing it here to make it available to MAS members, prior to a mass email announcement.

1-7/16" OAL This tiny pinfire, is modeled after James Bond's favorite, the Beretta Model 1934. I tried to be as faithful as possible to the look of the original and even tried to emulate the black plastic grips with the Pietro Beretta Logo. As with all my guns, however, the action is greatly simplified, and modified to fire the 2mm pinfire blank cartridge. On the right shows how in this underhammer pistol, the cartridge is loaded with the pin in the down position.

Beretta Model 1934 .....\$550.00  
 Glass top display box..... \$15.00  
 For more information contact Bob Urso, tel 360 733-4406 email boburso@comcast.net

or visit [http://home.comcast.net/~boburso/piccolo/4s\\_bobBER.htm](http://home.comcast.net/~boburso/piccolo/4s_bobBER.htm)

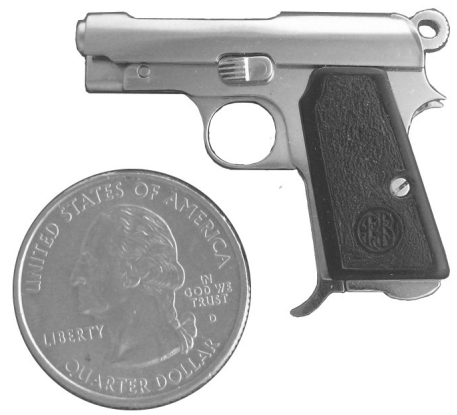

1/3scale paterson with all accessories 2000.00 and thacker long barrel paterson with all accessories very rare 5500.00

Contact Ron Weingarten (818) 360-5783



1/2scale mauser 2900.00



1/2scale luger 1600.00

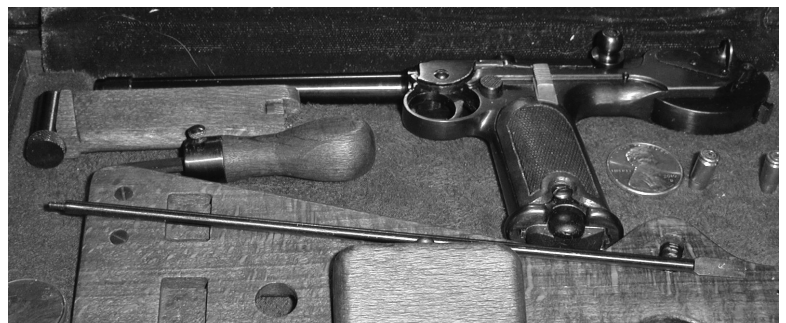

1/2 scale borchart with all accessories 2400.00

## Books by MAS Members

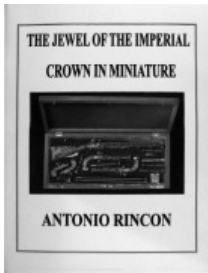

### The Jewel of the Imperial Crown in Miniature

The latest book on the work of Antonio Rincon, and his search for the history, tools, and materials to make the guns, made for Napoleon. \$90.00 plus postage

### Great Arms of A. Rincon

Full color, history of arms, featuring the miniatures of Antonio Rincon. 218 pages, hardcover, large format - 12" x 10" - fully illustrated, with dust jacket. \$90. To order contact Alice McGinnis, Tel. (608) 798-28860



### Cooper Tribute Book

3 manuscripts by John Cooper: Miniature Percussion Box Lock Pistols, Miniature Percussion Revolvers, and Miniature Revolvers with Hinged Sideplates. 72 pages, profusely illustrated, in colour. If you have been put off from buying this book because of the complicated procedure of buying from the UK - salvation is at hand. Alice McGinnis has a few copies for sale which she will send to first comers in exchange for \$35 including postage within the US." Alice McGinnis tel.(608) 798-2860

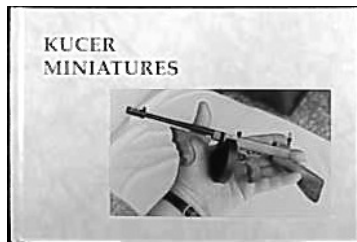
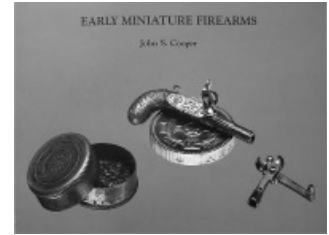

### The Miniature Firearms of David Kucer

6" X 8 7/8", hardbound, 64 pages, color and black and white, in English and French. A great book on Master miniature maker David Kucer. How he got started, with nice photos of many of his beautiful works. Price 25.00 plus postage. Contact David Kucer - tel (514) 935-9530 - email DMKucer@aol.com

How he got started, with nice photos of many of his beautiful works. Price 25.00 plus postage. Contact David Kucer - tel (514) 935-9530 - email DMKucer@aol.com

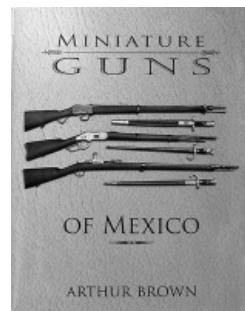

### Miniature Guns of Mexico

The definitive book on Tom Weston by Art Brown. Over 300 pages of photos that document the development of miniature arms in Mexico! Including Thacker, and Mr. Brown's personal collection. \$99 ~ Limited Edition \$10 Priority Shipping in the USA. To order call

1-800-MINIATURE

### The Tiniest Guns by Bob Urso

This thlird edition -160 pages- is the only reference for collectors of 2mm pinfire and rimfire berloque and charm pistols. \$25.50 post paid in the USA. \$32 to Europe. \$27 to Canada. Contact Bob Urso Tel. (360)733-4406 email boburso@comcast.net

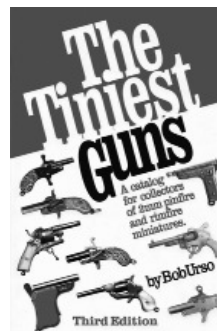

### Gold Colts by Nelson Perry

A pictorial study of the percussion Colt revolvers engraved and gold inlaid by Gustave Young. Written by recently departed MAS member Nelson Perry. 8 3/4" X 11 5/16", hardbound with color dust jacket. 206 pages. Numbered copy with color dust jacket: \$60.00. Numbered leather bound copy:\$120.00, Contact Wayne Driskill (281)485-1830 or (281)468-7103 cell, email driskill@hotmail.com

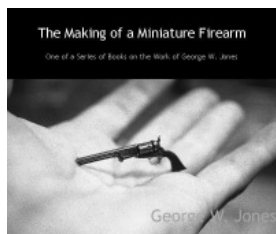

### The Making of a Miniature Firearm by George Jones

1/8th-scale Navy Colts, one set presented to James Cameron during the making of "Titanic", on which George worked, NRA medal winner, Winchester-Schuetzen rifle, in 1/8th-scale, a brace of percussion-pistols made for President Ronald Reagan. Order at [www.georgewjones.com](http://www.georgewjones.com)

Click on "check out my books"

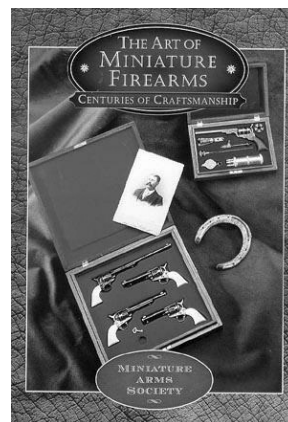

### The Art of Miniature Firearms by Art Brown, Morrow & Hall.

A publication of the Miniature Arms Society, it includes all the great makers past and present. Over 335 pages in full color. To order contact Alice McGinnis Tel. (608) 798-2860 email mcginnr@chorus.net

# Wayne Driskill Miniature Firearms

Pearland Texas, Tel (281) 485-1830 Cell (281) 468-7103 WWW.waynedriskillminiatures.com

Check out my website when you get a chance. Lots of new items added and lots of prices reduced.



1/3 scale Remington New Model Army percussion six shot revolver cased with accessories by master miniature maker David Kucer of Canada. 4 5/16" OAL. Blue finish, hammer and trigger in the white. Brass triggerguard with a nice patina. Barrel marked with the proper Remington barrel address., the bottom marked D.KUCER. This is one of my favorite Kucer pieces! Price: \$6,500.00



1/4 scale British Tower flintlock pistol by J. M. Vernon in England. 3 3/4" OAL. Fully functional, the barrel is bored to touch hole, lock has both half and full cock with a nice crisp action. Glass topped case, marked "J. M. Vernon, Hillside House, Baltonsborough, Glastonbury". Price: \$1,500.00

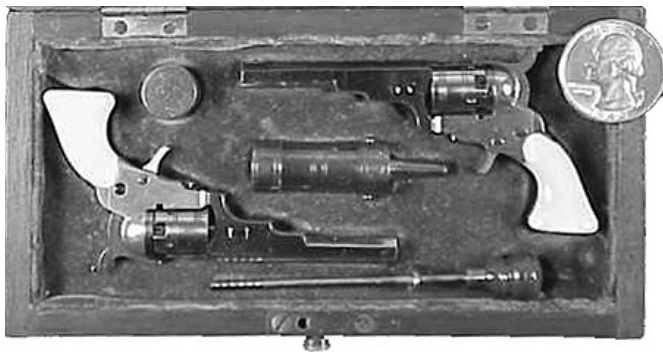

1/3 scale cased pair of Colt Texas #5 Paterson revolvers by Larry H. Smith. Very early - serial numbers 8 and 9. 3 1/8" OAL. Frames are brass, the steel parts in the white. Ivory grips They shoot the 2mm pinfire blanks. Manually indexed One spout powder flask that contains 47 2mm pinfire cartridges; and the original Larry Smith instruction page. This set was previously in the Sutherland and Rich Koury collections. Price: \$2,400.00



1/3 scale LeMatt by an unknown maker. This is a 9 shot revolver with a single shot shotgun barrel in the middle of the cyl-

inder. 4 3/8" OAL. Nose of the hammer flips down to change between firing the revolver cylinder and the shotgun barrel. Backstrap marked with the number 8. Fully functional and extremely well made! Price: \$6,500.00



An undiscovered Balogh? See page 23 for information. Price: \$1,500.00



5 shot ring gun on the Forsyth System. See page 24 for information.

Price: \$4,000.00

Below: 1/3 scale Chicago palm pistol made by master miniature maker Andrew Dyson in England. 2" long overall with a .65" barrel of .10 caliber. Fully functional. Nickel plated finish with checkered hard rubber side panels and grip. Price: \$2,195.00

